



Attachment 20: Bus Vision Standard

Guidance Notes

1 Introduction

All buses shall allow the driver to have sufficient vision of their surroundings to allow the execution of all driving tasks required in service in London.

All buses shall have a high standard of direct and indirect vision in areas close to the vehicle where vulnerable road users are at particular risk of collision with a bus undertaking low speed manoeuvres. This is referred to as close proximity vision.

This document sets out the guidance notes related to the assessment of Direct and Indirect Vision. These guidance notes are aimed at bus operators and OEMs as a practical guide for implementation of the Bus Safety Standard.

These notes are for guidance only and are not legally binding. In all circumstances, the guidance provided by an OEM or system supplier shall take precedence, and these guidance notes are only for use in the absence of other information. These are not intended to be exhaustive, but to point the operators toward practical advice and questions to raise with OEMs/suppliers.

2 Selection of buses/systems

Any bus that meets the TfL Bus Vehicle Specification.

The Direct and Indirect Vision requirements may be assessed against a new build bus, or against a vehicle fitted with an aftermarket retrofit vision system.

2.1 Compliance and warranty

A bus operator should ask to see compliance certificates for UNECE Regulation 46 and warranty information for any camera monitor system (CMS) from the bus OEM and/or the aftermarket supplier.

2.2 Requirement interpretation and application guidance

The requirements relate to both direct vision, where the driver looks directly through the windows and transparent areas of the bus structure in order to see the road and traffic environment outside, and indirect vision, where the driver looks in mirrors, monitors or other devices to see parts of the road and traffic environment around the vehicle.

In order allow the driver to recognise a potentially dangerous situation while undertaking low speed manoeuvring and successfully avoid a collision the following elements are required:



- **Available to be seen:** The hazard (pedestrian, cyclist, other vehicle etc.) needs to be available to be seen by the driver sufficiently ahead of time to allow avoiding action to be taken. That means the hazard needs to be in view at least approximately 2 seconds before collision
- **Alert and attentive:** The driver needs to be attentive to the road and traffic environment and alert to the possible need to react
- **Looking in the right direction:** In complex driving situations, the driving task can demand attention in multiple different directions; the driver needs to be looking in the right direction at the right time to see the hazard. In dynamic moving environments this is not guaranteed even if the driver is alert and attentive.
- **Recognition:** Once the hazard is seen, then the driver must recognise the hazard and the risk that it poses
- **Reaction:** Once the risk is recognised, the driver must react quickly and correctly to the risk; in some circumstances this may be steering around the hazard, in many it will be braking the vehicle to a stop and in others it might simply be to remain stationary instead of moving off from rest.

Direct vision and each different form of indirect vision have different benefits and disbenefits. The Bus Vision Standard and associated protocol recognises that current buses already have very good direct vision relative to other large vehicles and so sets a minimum criteria that ensures that standard is maintained in the face of other competing pressures in future. It allows for improvements over and above this minimum standard but also recognises that the opportunities for improvement are relatively small.

In addition to this, the Bus Vision Standard defines a minimum standard for the overall level of vision, whether implemented via direct or indirect vision. It is not prescribed how this should be achieved and allows for vision performance over and above the minimum standard. This leaves OEMs and operators to choose the solutions that work best with their designs and operations. In making those choices, OEMs and operators should bear in mind the requirements above, the guidance below about different aspects of different solutions and the interaction with systems such as blind spot warning or intervention systems (BSW) (see separate BSW requirements, test procedures and guidance documents).

2.3 Direct vision

Direct vision is generally seen as being more effective than indirect vision. This is because it offers benefits in the 'recognition' phase described above. For example, objects appear at life size, free from distortion and movement of a hazard relative to the vehicle is large and more likely to attract attention in peripheral vision. In addition to this, it is possible for drivers to make eye-contact with other road users around the vehicle which is thought to improve confidence that people have been seen and to help read intention of next moves. There is experimental evidence to show that drivers react significantly more quickly to the presence of vulnerable road users around the vehicle when they are seen via direct vision, rather than via indirect vision.

However, it is not practically possible to see all necessary areas around a large vehicle via direct vision. In particular any area significantly rearward of the driver's



eye point will be difficult because of the need for the driver to rotate eyes, neck and even body to direct their view there and because buses serve a purpose and seats, passengers and other structural elements cannot all be made transparent.

2.4 Indirect vision

The use of mirrors or camera monitor systems can be cost effective solutions that allow areas to the rear of the driver's eyes or specific blind spots in the forward field of view to be easily seen. However, as previously discussed, experimental evidence has shown the ability of drivers to recognise hazards can be more difficult when reliant on indirect vision rather than via direct vision. The following should be considered when implementing indirect vision:

- **Adjustment:** Poor adjustment of mirrors, camera views and monitors can substantially reduce the available view from the device. Operators should request guidance from the OEM or aftermarket supplier regarding the correct adjustment of the mirror or CMS.
- **Conflicts with direct vision:** Mirrors or monitors placed in areas around windows will can cause some obstruction to direct vision. In this case smaller devices may be considered preferable. However, compromises that position devices in places where direct vision is less important or where it coincides with existing less avoidable obstructions such as A-pillars already exist may be better, bearing in mind the possible recognition benefits of larger images.
- **Distortion:** Strongly curved mirrors or fish eye camera lenses can produce very large fields of view from a single source, which can be seen as a benefit if the size of the view is all that is considered and not the quality of the image. Each of these techniques can also produce distorted images that may make it harder for drivers to recognise hazards and interpret risk particularly during quick mirror checks. However, sophisticated software in some camera monitor systems may be able to enhance images in poor conditions such that image quality is higher than with equivalent mirrors.
- **Driver workload:** Evidence in HGVs suggests that scanning direct vision and up to 6 mirrors during a complex low speed manoeuvre takes a significant amount of time. This increases driver workload such that although a hazard may more often be 'available to be seen' the driver may be looking in the right place at the right time less frequently, while still being diligently attentive and alert. Thus, indirect vision devices that add to driver workload by increasing the number of places they need to look or by requiring them to move their gaze further from the other areas they need to scan are likely to increase driver workload. This may detract from, or even reverse, the other benefits that the devices provide.
- **Image size:** Hazards seen in mirrors or monitors will are typically be smaller than life size and their relative motion with the vehicle less easy to identify in peripheral vision. Thus, larger mirrors or monitors may be preferable to smaller devices.

The protocol has been designed to minimise the likelihood of such occurrences and requires compliance with the minimum standards set in these respects by UNECE Regulation 46. However, a wide range of differences in approach are still possible



within these constraints and OEMs and operators should aim to select the best solutions they can bearing in mind these factors and their other operational constraints.

A camera monitor system which is intended to replace mirrors may resolve some of the potential conflicts by varying the views displayed on its monitors, depending on the vehicle and traffic situation at the time. For example, class II mirrors may be removed and replaced by a rectangular monitor mounted on each A-pillar. The camera system may also be capable of showing a class V close proximity side view and/or a rear view immediately behind the vehicle. When travelling forward at normal speeds the offside mirror may show the class II display only, the nearside may show a large class II display and a small class V display. At low speeds when indicators are activated this ratio may reverse such that a large class V view is displayed and a small class II. When reverse is selected perhaps both monitors may show a 50/50 class II and rear vision view. This approach has clear potential benefits but is a new technology and the workload requirements and effects on recognition are not clearly understood at this time. Such systems are well worth investigation, but operators may wish to consider trialling them in pilot phases with objective feedback from drivers before widespread rollout.

3 Training

3.1 For test Services

The recommended method to complete the assessment involves the use of CAD and finite element (FE) modelling. Therefore, the respective test service conducting an assessment should have the relevant expertise to implement such techniques.

Test services accredited to undertake approval tests to UNECE Regulation 46 will be considered suitable to undertake performance tests if they can also prove the necessary CAD and FE expertise. Test services without such accreditation will be required to demonstrate to TfL at their own expense that they can achieve the same standard of testing as an accredited organisation.

3.2 Bus Drivers

Drivers should be trained to correctly adjust mirrors and/or CMS to provide the required field of view, in accordance with the guidance from the OEM or aftermarket supplier.

Where a monitor is used to meet the indirect vision requirements, drivers should be trained to understand the orientation and perspective of the image. In particular, where a camera monitor system replaces existing mirrors, drivers should be thoroughly familiarised with the system.

3.3 Shift Supervisors

Supervisors should ensure drivers correctly adjust mirrors and/or CMS to provide the required field of view and are familiar with the image provided by camera monitor systems.



3.4 Bus Maintenance Engineers

The engineers carrying out general bus maintenance should be aware of the location and details of any cameras related to a CMS. Training should be based on the OEM's guidance. This should include understanding the importance of ensuring the cameras are correctly aligned, undamaged and unobstructed.

4 Maintenance

Operators are encouraged to establish what (if any) daily checks are required, and to plan for these additional operational costs.

5 Repair

If during system maintenance checks (Section 4) any of the mirrors and/or cameras is deemed to be faulty or failing they should be replaced as soon as possible. The extent of the vision provided by the mirrors and/or cameras is completely contingent on the mirrors and cameras being clean and undamaged.



Attachment 21: Blind Spot Mirrors

Guidance Notes

1 Introduction

All buses shall allow the driver to have sufficient vision of their surroundings to allow the execution of all driving tasks required in service in London.

All buses shall have a high standard of direct and indirect vision in areas close to the vehicle where vulnerable road users are at particular risk of collision with a bus undertaking low speed manoeuvres. This is referred to as close proximity vision.

This document sets out the guidance notes related to the assessment of Direct and Indirect Vision, specifically in relation to blind spot mirrors. These guidance notes are aimed at bus operators and OEMs as a practical guide for implementation of the Bus Safety Standard.

These notes are for guidance only and are not legally binding. In all circumstances, the guidance provided by an OEM or system supplier shall take precedence, and these guidance notes are only for use in the absence of other information. These are not intended to be exhaustive, but to point the operators toward practical advice and questions to raise with OEMs/suppliers.

2 Selection of buses/systems

Any bus that meets the TfL Bus Vehicle Specification.

The Direct and Indirect Vision requirements may be assessed against a new build bus, or against a vehicle fitted with an aftermarket retrofit blind spot mirror system.

2.1 Compliance and warranty

A bus operator should ask to see documentary evidence of compliance with the requirements.

2.2 Considerations for the utilisation of Blind spot mirrors

The use of mirrors can be a cost-effective solution that allow areas to the rear of the driver's eyes or specific blind spots in the forward field of view to be easily seen. However, experimental evidence has shown the ability of drivers to recognise hazards can be more difficult when reliant on indirect vision rather than via direct vision. The following should be considered when utilising indirect vision:

- **Adjustment:** Poor adjustment of blind spot mirrors can substantially reduce the useful available view from the device. Operators should request guidance from the OEM or aftermarket supplier regarding the correct adjustment of the mirror.



- **Distortion:** Strongly curved mirrors can produce very large fields of view from a single source, which can be seen as a benefit if the size of the view is all that is considered and not the quality of the image. They can however also produce distorted the images that may make it harder for drivers to recognise hazards and interpret risk particularly during quick mirror checks.
- **Driver workload:** Evidence in HGVs suggests that scanning direct vision and up to 6 mirrors during a complex low speed manoeuvre takes a significant amount of time. This increases driver workload such that, although a hazard may more often be 'available to be seen', the driver may be looking in the right place at the right time less frequently, while still being diligently attentive and alert. Thus, indirect vision devices that add to driver workload by increasing the number of places they need to look or by requiring them to move their gaze further from the other areas they need to scan are likely to increase driver workload. This may detract from, or even reverse the other benefits that the devices provide.
- **Image size:** Hazards seen in mirrors will are typically be smaller than life size and their relative motion in regard to the vehicle less easy to identify in peripheral vision. Thus, larger mirrors may be preferable to smaller devices.

A wide range of differences in approach are still possible within these constraints and OEMs and operators should aim to select the best solutions they can bearing in mind these factors and their other operational constraints.

3 Training

3.1 Bus drivers

Drivers should be trained to appropriately install and correctly adjust mirrors to provide the required field of view, in accordance with the guidance from the OEM or aftermarket supplier.

3.2 Shift Supervisors

Supervisors should ensure drivers correctly adjusting mirrors to provide the required field of view.

4 Maintenance

Operators are encouraged to establish what (if any) daily checks are required, and to plan for these additional operational costs.

5 Repair

If during system maintenance checks (section 4) any of the mirrors are deemed to be faulty or failing they should be replaced as soon as possible. The extent of the vision provided by the mirrors is completely contingent on them being clean and undamaged.



Attachment 22: Camera Monitor Systems (CMS) Guidance Notes

1 Introduction

All buses shall allow the driver to have sufficient vision of their surroundings to allow the execution of all driving tasks required in service in London.

All buses shall have a high standard of direct and indirect vision in areas close to the vehicle where vulnerable road users are at particular risk of collision with a bus undertaking low speed manoeuvres. This is referred to as close proximity vision.

This document sets out the guidance notes related to the assessment of Direct and Indirect Vision, specifically in relation to camera monitor systems. These guidance notes are aimed at bus operators and OEMs as a practical guide for implementation of the Bus Safety Standard.

These notes are for guidance only and are not legally binding. In all circumstances, the guidance provided by an OEM or system supplier shall take precedence, and these guidance notes are only for use in the absence of other information. These are not intended to be exhaustive, but to point the operators toward practical advice and questions to raise with OEMs/suppliers.

2 Selection of Buses/Systems

Any bus that meets the TfL Bus Vehicle Specification.

The Direct and Indirect Vision requirements may be assessed against a new build bus, or against a vehicle fitted with an aftermarket retrofit camera monitor system.

2.1 Compliance and Warranty

A bus operator should ask to see compliance certificates for UNECE Regulation 46 and warranty information for any camera monitor system (CMS) from the bus OEM and/or the aftermarket supplier.

Considerations for the utilisation of Camera Monitoring System The use of camera monitor systems can be an effective solution to allow areas to the rear of the driver's eyes or specific blind spots in the forward field of view to be easily seen. However, experimental evidence has shown the ability of drivers to recognise hazards can be more difficult when reliant on indirect vision rather than via direct vision. The following should be considered when utilising indirect vision:

- **Adjustment:** Poor adjustment can substantially reduce the useful available view from the device. Operators should request guidance from the OEM or aftermarket supplier regarding the correct adjustment of the CMS.
- **Conflicts with direct vision:** Monitors placed in areas around windows will can cause some obstruction to direct vision. In this case smaller devices may



be considered preferable. However, compromises that position devices in places where direct vision is less important or where it coincides with existing less avoidable obstructions (e.g. A-pillars or driver assault screen frames) may be better, bearing in mind the possible recognition benefits of larger images.

- **Distortion:** Fish-eye camera lenses can produce very large fields of view from a single source, which can be seen as a benefit if the size of the field of view is all that is considered and not the quality of the image. This can however also produce distorted images that may make it harder for drivers to recognise hazards and interpret risk, particularly during quick mirror checks. However, sophisticated software in some camera monitor systems may be able to enhance images in poor conditions such that image quality is higher than with equivalent mirrors.
- **Driver workload:** Evidence in HGVs suggests that scanning direct vision and up to 6 mirrors during a complex low speed manoeuvre takes a significant amount of time. This increases driver workload such that, although a hazard may more often be 'available to be seen', the driver may be looking in the right place at the right time less frequently, while still being diligently attentive and alert. Thus, indirect vision devices that add to driver workload by increasing the number of places they need to look or by requiring them to move their gaze further from the other areas they need to scan are likely to increase driver workload. This may detract from, or even reverse the other benefits that the devices provide.
- **Image size:** Hazards seen in monitors will typically be smaller than life size and their relative motion with the vehicle less easy to identify in peripheral vision. Thus, larger monitors may be preferable to smaller devices.

A wide range of differences in approach are still possible within these constraints and OEMs and operators should aim to select the best solutions they can bearing in mind these factors and their other operational constraints.

A camera monitor system which is intended to replace mirrors may resolve some of the potential conflicts by varying the views displayed on its monitors, depending on the vehicle and traffic situation at the time. For example, Class II mirrors may be removed and replaced by a rectangular monitor mounted on each A-pillar. The camera system may also be capable of showing a Class V close proximity side view and/or a rear view immediately behind the vehicle. When travelling forward at normal speeds the offside mirror may show the class II display only, the nearside may show a large Class II display and a small Class V display. At low speeds when indicators are activated this ratio may reverse such that a large Class V view is displayed and a small Class II. When reverse is selected perhaps both monitors may show a 50/50 Class II and rear vision view. This approach has clear potential benefits but is a new technology and the workload requirements and effects on recognition are not clearly understood at this time. Such systems are well worth investigation, but operators may wish to consider trialling them in pilot phases with objective feedback from drivers before widespread rollout.



3 Training

3.1 Bus drivers

Drivers should be trained to correctly adjust the CMS to provide the required field of view, in accordance with the guidance from the OEM or aftermarket supplier.

Where a monitor is used to meet the indirect vision requirements, drivers should be trained to understand the orientation and perspective of the image. In particular, where a camera monitor system replaces existing mirrors, drivers should be thoroughly familiarised with the system.

Further guidance on installation is to be provided when CMS HMI guidelines are produced.

3.2 Shift Supervisors

Supervisors should ensure drivers correctly adjust CMS to provide the required field of view and are familiar with the image provided by camera monitor systems.

4 Maintenance

Operators are encouraged to establish what (if any) daily checks are required, and to plan for these additional operational costs.

5 Repair

If during system maintenance checks (section 4) any of the cameras or monitors are deemed to be faulty or failing they should be replaced as soon as possible. The extent of the vision provided by the CMS is completely contingent on the cameras and monitors being clean and undamaged.

Training should be provided to mechanics/engineers on how to appropriately maintain and replace CMS systems.



Attachment 23: Rear view Camera Monitor Systems (CMS) Guidance Notes

1 Introduction

All buses shall allow the driver to have sufficient vision of their surroundings to allow the execution of all driving tasks required in service in London.

All buses shall have a high standard of direct and indirect vision in areas close to the vehicle where vulnerable road users are at particular risk of collision with a bus undertaking low speed manoeuvres. This is referred to as close proximity vision.

This document sets out the guidance notes related to the assessment of Direct and Indirect Vision, specifically in relation to rear-view camera monitor systems. These guidance notes are aimed at bus operators and OEMs as a practical guide for implementation of the Bus Safety Standard.

These notes are for guidance only and are not legally binding. In all circumstances, the guidance provided by an OEM or system supplier shall take precedence, and these guidance notes are only for use in the absence of other information. These are not intended to be exhaustive, but to point the operators toward practical advice and questions to raise with OEMs/suppliers.

2 Selection of buses/systems

Any bus that meets the TfL Bus Vehicle Specification.

The Direct and Indirect Vision requirements may be assessed against a new build bus, or against a vehicle fitted with an aftermarket retrofit rear-view camera monitor system.

2.1 Compliance and warranty

A bus operator should ask to see compliance certificates for UNECE Regulation 46 and warranty information for any rear-view camera monitor system (CMS) from the OEM and/or the aftermarket supplier. The compliance is with regard to the technical quality of view only.

2.2 Considerations for the utilisation of Rear View CMS

The use of camera monitor systems can be an effective solution to allow areas to the rear of the driver's eyes or specific blind spots in the forward field of view to be easily seen. However, experimental evidence has shown the ability of drivers to recognise hazards can be more difficult when reliant on indirect vision rather than via direct vision. The following should be considered when utilising indirect vision:



- **Adjustment:** Poor adjustment can vary substantially greatly and therefore reduce the useful available view from the device. Operators should request guidance from the OEM or aftermarket supplier regarding the correct adjustment of the CMS.
- **Conflicts with direct vision:** Monitors placed in areas around windows will can cause some obstruction to direct vision. In this case smaller devices may be considered preferable. However, compromises that position devices in places where direct vision is less important or where it coincides with existing less avoidable obstructions (e.g. A-pillars or driver assault screen frames) may be better, bearing in mind the possible recognition benefits of larger images.
- **Distortion:** Fish-eye camera lenses can produce very large fields of view from a single source, which can be seen as a benefit if the size of the field of view is all that is considered and not the quality of the image. This can however also produce distorted images that may make it harder for drivers to recognise hazards and interpret risk particularly during quick mirror checks. However, sophisticated software in some camera monitor systems may be able to enhance images in poor conditions such that image quality is higher than with equivalent mirrors.
- **Driver workload:** Evidence in HGVs suggests that scanning direct vision and up to 6 mirrors during a complex low speed manoeuvre takes a significant amount of time. This increases driver workload such that, although a hazard may more often be 'available to be seen', the driver may be looking in the right place at the right time less frequently, while still being diligently attentive and alert. Thus, indirect vision devices that add to driver workload by increasing the number of places they need to look or by requiring them to move their gaze further from the other areas they need to scan are likely to increase driver workload. This may detract from, or even reverse the other benefits that the devices provide.
- **Image size:** Hazards seen in monitors will are typically be smaller than life size and their relative motion with the vehicle less easy to identify in peripheral vision. Thus, larger monitors may be preferable to smaller devices.

A wide range of differences in approach are still possible within these constraints and OEMs and operators should aim to select the best solutions they can bearing in mind these factors and their other operational constraints.

3 Training

3.1 Bus drivers

Drivers should be trained, whether necessary, to correctly adjust the rear-view CMS to provide the required field of view, in accordance with the guidance from the OEM or aftermarket supplier.

Where a monitor is used to meet the rear-view indirect vision requirements, drivers should be trained to understand the orientation and perspective of the image.



Further guidance on installation is to be provided when CMS HMI guidelines are produced.

3.2 **Shift Supervisors**

Supervisors should ensure drivers correctly adjust CMS to provide the required field of view and are familiar with the image provided by camera monitor systems.

4 **Maintenance**

Operators are encouraged to establish what (if any) daily checks are required, and to plan for these additional operational costs.

5 **Repair**

If during system maintenance checks (section 4) any of the cameras or monitors are deemed to be faulty or failing they should be replaced as soon as possible. The extent of the vision provided by the CMS is completely contingent on the cameras and monitors being clean and undamaged.

Training should be provided to mechanics/engineers on how to appropriately maintain and replace CMS systems.



Attachment 24: Blind Spot Warning (BSW) Assessment Protocol

1 Introduction

Blind Spot Information and Warning (BSW) systems are used to inform drivers of the potential hazards presented by vulnerable road users in close proximity to the bus to support safe execution during low speed turns to the nearside and when moving off from rest.

This document presents a procedure for proving that a vehicle that is approved as compliant with UNECE Regulation No. 151, which requires information signals to be issued when pedestrians are detected to the nearside of the vehicle, can also issue an information and warning system in situations where a bus is turning to the nearside and is at risk of colliding with a pedestrian.

For full understanding of this Attachment, it should be read in conjunction with the Attachment 25: Blind Spot Warning (BSW) Guidance Notes and New Bus Specification, Section 4.3.4.5.

2 Scope

This protocol applies to all new buses intended for service under contract to TfL that are passenger vehicles with a maximum mass exceeding 5 tonnes and a capacity exceeding 22 passengers. The passenger vehicles will be capable of carrying seated but unrestrained occupants and standing occupants. Such vehicles are categorised in the Consolidated Resolution on the Construction of Vehicles (R.E.3) as M3; Class I.

Note, this standard is intended for application in the UK where vehicles drive on the left-hand side of the road. However, application to regions where vehicles drive on the right-hand side can be achieved by reflecting all scenarios and references to left and right about the longitudinal plane of the vehicle (global X-axis).

3 Purpose

The aim of the Blind spot warning assessment protocol is to provide objective assessments that can be used to enforce minimum standards for systems installed on vehicles to assist the driver and reduce the likelihood of collisions with vulnerable road users at low vehicle speeds. This protocol only covers the extension of capabilities already required by Regulation, which requires buses to inform the driver of a cyclist to the nearside and warns the driver if the situation changes such that a collision with the cyclist becomes imminent. This protocol aims to extend that performance to situations involving a pedestrian crossing a side road that the bus may turn into.



The term blind spot warning has arisen because over many years blind spots have been identified as a contributory factor in collisions between HGVs and pedestrians and cyclists which resulted in death or seriously injury. The Bus Vision Standard assessment (Attachment 19) has been defined to ensure buses continue to benefit from high standards of direct vision, however it is clear that better vision alone does not eliminate risk. Collisions where pedestrians and cyclists are killed or seriously injured when positioned in close proximity to a moving bus do still occur, even where the VRU was available to be seen by the driver immediately before collision. Action in this area has largely evolved on the basis of documented collision cases for HGVs. Where HGVs are involved, the most common cases are pedestrians killed in collisions with the front of a vehicle as it moves off from rest (in a straight line) and cyclists travelling at the nearside of an HGV and in the same direction, that are killed when the HGV turns left. These collisions do sometimes occur with buses, but the most common low speed manoeuvring collision involving buses is where a bus turns into a side road at the nearside and a pedestrian that was crossing that side road collides with the nearside of the bus towards the front.

United Nations Regulations are applied to buses but were developed on the basis of HGV collisions so do not consider the most important case for buses. This protocol is intended to extend the regulatory requirements to that situation.

Information signals are intended to activate any time the relevant VRU is close to the vehicle. such that they would be at risk IF the driver chose to turn the bus. In London conditions these signals will be issued frequently and in most cases the driver will not need to take urgent action. As such, these should be visual signals that are clearly visible to the driver but do not excessively irritate the driver.

Collision warnings should only be issued when the driver urgently needs to take action to avoid collision. These circumstances should only occur very rarely, in comparison to the approximately 480 million bus km travelled in London each year. As such, these warnings should be highly alerting and stand out as an unusual event demanding the driver's attention and drawing that attention to where the hazard can be seen in direct or indirect vision.

4 Normative References

The following normative documents, in whole or in part, are referenced in this document and are indispensable for its correct application. For dated references only the edition cited applies. For undated references the latest edition of the referenced document (including any amendments) applies.

- London Bus Service Limited New Bus Specification Section 4.3.4.5
- London Bus Service Limited New Bus Specification - Attachment 25: Blind Spot warning guidance
- Regulation (EU) 2018/858 of the European Parliament and of the Council of 30th May 2018 on the approval and market surveillance of motor vehicles and their trailers, and of systems, components and separate technical units intended for such vehicles, amending Regulations (EC) No 715/2007 and (EC) No 595/2009 and repealing Directive 2007/46/EC
- UN ECE Regulation 61 Uniform provisions on the external projections of commercial vehicles



- UN ECE Regulation 107 Uniform provisions concerning the approval of category M₂ or M₃ vehicles with regard to their general construction
- UN ECE Regulation No 151: Uniform provisions concerning the approval of motor vehicles with regard to the Blind Spot Information System for the Detection of Bicycles E/ECE/TRANS/505/Rev.3/Add.150/Amend.4 - [UN Regulation No. 151 - Amend.4](#)
- UNECE Regulation 159: Uniform provisions concerning the approval of motor vehicles with regard to the Moving Off Information System for the Detection of Pedestrians and Cyclists ECE/TRANS/WP.29/2020/122
- Commission Regulation (EU) No 1230/2012 implementing Regulation (EC) No 661/2009 of the European Parliament and of the Council with regard to type-approval requirements for masses and dimensions of motor vehicles and their trailers and amending Directive 2007/46/EC of the European Parliament and of the Council.
- ISO 612:1978 Road Vehicles – Dimensions of motor vehicles and towed vehicles – terms and definitions.
- ISO 15037-2: 2006: *Road Vehicles – Vehicle dynamics test methods - General conditions for heavy vehicles and buses*
- ISO 19206: Road vehicles. Test devices for target vehicles, vulnerable road users and other objects for assessment of active safety functions. Part 2: Requirements for pedestrian targets

5 Definitions

For the purpose of this Protocol:

- **Approval Authority** - The body within TfL that certifies that a bus is approved for use in the TfL fleet and assigns its score under the bus safety standard for use in procurement processes.
- **Blind Spot information signal, Warning and intervention (BSW) system** - A complete system, encompassing both the defined blind spot safety functions and enabling technologies, that informs the driver of a VRU in close proximity to the vehicle, warns the driver of an imminent collision with a VRU.
- **Blind spot safety function** – These functions are defined by the action that the enabling technologies take to either improve the chances of a driver acting appropriately should a VRU be in the vehicle blind spot. They include:
 - a) **VRU proximity information signal** - A signal informing the driver that a VRU has been detected in close proximity to the vehicle. A proximity information signal (which may be referred to as an information signal), is a medium urgency signal that reflects the fact that the driver may or may not be aware of the presence of the VRU and that there may or may not be an imminent risk of collision.
 - b) **VRU collision warning signal** - A signal issued to the driver where an imminent collision between the VRU and the vehicle is calculated as likely. Such a system shall not warn the driver of the simple presence of a



VRU in close proximity. A collision warning is a high urgency signal that warns the driver of the vehicle that a collision is imminent.

- **Enabling technologies** - The technologies that enable the blind spot safety function through the combination of sensor components, decision-making algorithms and the components utilised to implement the blind spot safety function.
- **Human Machine Interface (HMI)** - The part of a BSW system that interacts with the driver and includes controls and settings for activating or adjusting the application as well as the means by which information and warning signals are communicated from the system to the driver.
- **Information Signal or collision warning mode** - The method of transmitting a signal to a driver and consisting of four key modes including: audible (tonal), audible (speech), visual or haptic.
- **OEM: Original Equipment Manufacturer** – The company responsible for the manufacture of a complete bus, delivered to a bus operator
- **Test Service** - The organisation undertaking the testing and certification of the results to the Approval Authority.
- **Test Target** - A test dummy that accurately represents the characteristics of the relevant VRU, as seen by the relevant sensing technologies used by BSW. The specific test target used in this annex will be an adult Pedestrian target (EPTa) complying with ISO 19206-2.
- **Time to Collision (TTC)** - The time it would take for the vehicle to reach the point of collision if the speed and trajectory of the vehicle remained constant when calculated at any instant in time. If the bus and pedestrian are on a parallel or diverging path, they are not on course for an impact and TTC will be infinite. If the two are on a converging path at constant vehicle speeds, the TTC will reduce steadily over time. If speed is reduced, however, TTC increases and if sufficient braking is applied to avoid a collision then the TTC tends towards infinity. For the purposes of this protocol TTC will be calculated for the straight path of the pedestrian based on its distance from the theoretical collision point in metres divided by its speed in metres per second.
- **Vehicle Length:** The distance in the x-axis at the longest point of the vehicle and measured in accordance with the definition contained in Commission Regulation (EU) no 1230/2012, when excluding the following components:
 - a) Wiper and washer devices
 - b) Front or rear marker plates
 - c) Lighting and light signalling devices
 - d) Mirrors or other devices for indirect vision
 - e) Watching and detection aids including RADAR
 - f) Coupling and recovery towing devices for power driven vehicles
 - g) Trolleybus current collection devices
 - h) Exhaust pipes



- **Vehicle Under Test (VUT)** - Means the vehicle being assessed according to this protocol.
- **Vehicle width:** The distance in the y-axis at the widest point of the vehicle and measured in accordance with the definition contained in Commission Regulation (EU) no 1230/2012, when excluding the following components:
 - i) Mirrors or other devices for indirect vision
 - j) Bulge in the tyre at the point of contact with the road
 - k) Tyre failure tell-tale devices and pressure indicators
 - l) Side marker lamps, service door lighting and other side mounted lamps and retroreflectors
 - m) Access ramps, retractable steps and lift platforms etc.
 - n) Watching and detection aids including RADAR
 - o) Flexible mudguards
 - p) Snow chains
- **Vulnerable Road Users (VRU):** Means pedestrians or cyclists. For the purpose of this document, only adult pedestrians are referenced.

6 Reference system

6.1 Local co-ordinates

A local co-ordinate system (x,y,z) for the VUT shall be defined such that the x-axis points toward the front of the bus, the y-axis towards the left and the z-axis upwards, as shown in Figure 24_1. The origin of the co-ordinate system shall lie on the ground plane at the intersection of the centreline of the bus and a vertical transverse plane passing through the foremost point of the vehicle.

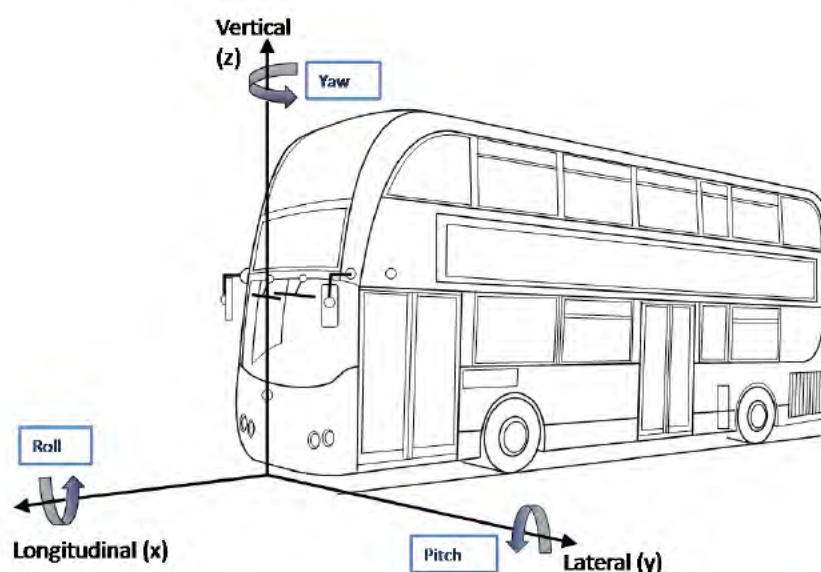

Figure 24_1: Local coordinate system and notation for VUT



6.2 Global co-ordinates

A global co-ordinate system (X, Y, Z) fixed relative to the Earth shall be defined such that the global X-axis is coincident with the local x-axis of the vehicle in its initial starting position. Thus, a VRU travelling perpendicular to the initial direction of the VUT would be travelling along the global Y-axis.

6.3 Test Target coordinates

The local coordinate systems (x,y,z) for the EPTa test target shall be defined such that the x-axis points in the direction of walking, the y-axis towards the left and the z-axis upwards. The origin of the coordinate system shall lie on the ground plane, at the intersection of the test target centreline and a line perpendicular to the centreline passing through the test target hip point, as shown in Figure 24_2.

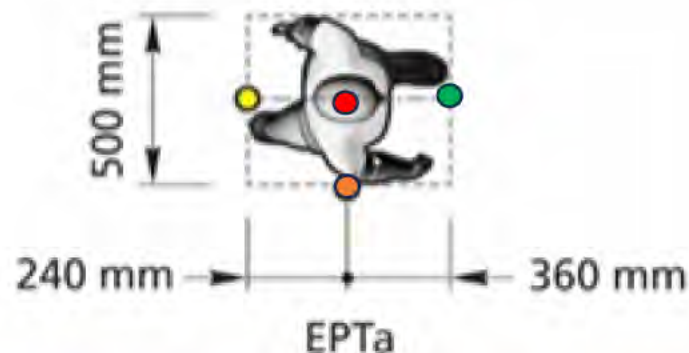

Figure 24_2: Origin of local coordinate systems for EPTa test target, illustrating centrelines (grey), local coordinate system origin (red), test target hip point (orange) and front reference point (green)



7 Measurements and variables

7.1 Variables to be measured

The variables which shall be measured continuously throughout testing can be seen in Table 24_1: Minimum variables to be measured continuously during testing with minimum operating ranges and maximum overall permitted measurement errors, along with the minimum operating ranges and measurement accuracy required.

Variable	Operating range (at least)	Measurement accuracy
Position (global coordinates) of vehicle under test (VUT_x , VUT_y)	200m in X-axis 100m in Y-axis	$\pm 0.03\text{m}$
Position (global coordinates) of VRU test target (VRU_x , VRU_y)	200m in X-axis 100m in Y-axis	$\pm 0.05\text{m}$
Speed of vehicle under test (V_{VUT})	0km/h to 30km/h	0.1km/h
Speed of VRU test target (V_{TT})	0km/h to 12.5km/h	0.1km/h
Heading (yaw) angle (θ) relative to global X-axis (θ_{TV} , θ_{TT})	0° to 360°	0.1°
Longitudinal acceleration of vehicle under test (A_{VUT})	$\pm 15\text{m/s}^2$	0.1m/s^2
Activation of information and warning signals	Binary active / inactive	Time delay $\leq 25\text{ms}$

Table 24_1: Minimum variables to be measured continuously during testing with minimum operating ranges and maximum overall permitted measurement errors

Additional variables which shall be measured on a periodic basis, both before each test and at least every 30 minutes during testing, can be seen in 24_2, along with minimum operating ranges and maximum overall permitted measurement errors.

Variable	Operating range (at least)	Measurement accuracy
Ambient Temperature	-5°C to $+50^\circ\text{C}$	$\pm 1^\circ\text{C}$
Wind Speed	0m/s to 20m/s	$\pm 0.2\text{m/s}$
Ambient Illumination	0lux to 150,000lux	$\pm 10\%$

Table 24_2: Additional variables to be measured periodically during testing with minimum operating ranges and maximum overall permitted measurement errors

7.2 Measuring equipment

Details of the sensors used to measure the required variables shall be recorded in the test report together with the position in which they are installed within the vehicle (measured relative to the local co-ordinate system for the VUT).



The default equipment to be used shall be a high-quality inertial navigation system in combination with GPS positioning capable of measuring vehicle position with an accuracy of 5cm or better. Data shall be recorded at a sample rate of at least 100 Hz, which has been found to provide all continuously measured variables with sufficient accuracy. With such equipment, post-sampling digital filtering shall be as follows:

- a) Position and speed need no additional digital filtering after data capture;
- b) Acceleration and yaw rate shall be filtered with a phaseless digital filter complying with the requirements of ISO 15037-2:2002.

Alternatively, any measuring equipment that can be demonstrated to be compliant with the requirements of ISO 15037-2:2002 is permitted.

In addition to the data recording described above, the VUT shall be equipped with one or more video cameras positioned such that for each and every test, the TT can be clearly seen at the moment of impact, at impact points ranging from 1% to 99% of the vehicle width. When conducting test the video feed shall be synchronised to the data recordings, with a delay of less than 50ms. This camera footage is intended for engineering use only in order to provide a visual reference to allow cross-checking of post-processed data. Camera mounting position, lens type etc. are not considered important for this purpose provided, impact position or timing of avoidance can clearly be seen in the resulting footage.

8 Test Conditions

8.1 Test Track

Tests shall be undertaken on a uniform, solid-paved surface with a consistent slope in any direction of between 0% and 1%. The surface must be paved and may not contain any irregularities (e.g. large dips or cracks, manhole covers or reflective studs) that may give rise to abnormal sensor measurements within a lateral distance of 3.0m to either side of the test path and within a longitudinal distance of 30m ahead of the VUT when the test ends.

8.2 Surroundings

The general view ahead and to either side of the test area shall comprise of a wholly plain manmade or natural environment (e.g. further test surface, plain coloured fencing or hoardings, natural vegetation or sky etc.) and must not comprise any highly reflective surfaces or contain any vehicle-like silhouettes that may give rise to abnormal sensor measurements.

8.3 Weather Conditions

Tests shall be undertaken only in compliance with the following weather conditions:

- a) Ambient temperatures shall be between 0°C and 45°C
- b) No precipitation shall be falling during testing. The surface is permitted to be damp during testing but the quantity of water present on the surface must be less than the amount liable to cause splash or spray during the test.
- c) Horizontal visibility at ground level shall be greater than 100m.



- d) Wind speeds shall be below 6m/s average, gusting to 10m/s.
- e) Ambient illumination must be homogenous in the test area and in excess of 15 lux.

8.4 Test Targets

Adult Pedestrian test targets complying with ISO 19206 shall be used for the test. The test target shall be moved around the test area and delivered to the point of impact with the VUT by a low-profile platform.

The system will be capable of moving the vulnerable road user at speeds in excess of 5 km/h, to accelerate at 3 m/s² or more, and maintaining constant speed within a tolerance of 0.25km/h. Lateral deviation from an intended straight path shall be no more than 0.05m.

Any visible parts of the combined platform and VRU mounting system shall be of a uniform colour that blends well with the test track beneath it. The default colour is grey.

The platform and VRU mounting system shall not influence RADAR return and RADAR absorbing material may be used at the VRU mounting points to ensure compliance with this requirement.

The distance between the lower edge of the VRU and the road surface shall be less than 75 mm.

9 Vehicle preparation

9.1.1 Settings

Some systems may incorporate driver configurable settings. Where those settings can influence performance, for example the sensitivity of proximity information signal or collision warnings, they shall be set to the middle setting (midpoint), or where this is not possible to the next latest possible setting. Examples are illustrated in 24_3, where a setting that would tend to make an information signal or warning later is one that would reduce the range or sensitivity of the application, whilst earlier would tend to make the application more sensitive or to detect at longer range.

Early	Setting 1		Setting 2		Late
	Setting 1	Setting 2		Setting 3	
	Setting 1	Setting 2	Setting 3	Setting 4	

Table 24_3: Blind spot safety system setting for testing

In this way, a system with only two settings gets adjusted to the least sensitive setting, or latest intervention, a system with 3 possible settings gets adjusted to the midpoint and a system with four settings gets adjusted to the sensitivity setting below the midpoint.



9.2 Tyres

Perform the testing with road legal tyres of the size, speed and load rating specified by the OEM. Inflate tyres to the pressures recommended by the OEM for the least laden normal condition (unladen or lightly laden). Tyre pressures immediately before the test shall be recorded in the Test Report.

9.3 Vehicle Mass

BSW shall be operative at all states of Load.

The VUT shall be tested and assessed unladen with only the driver, test equipment and necessary qualified test service personnel on board.

All test equipment installed in the vehicle should be securely attached such that it cannot move under maximum braking forces.

9.4 Driving control systems

The VUT shall be equipped with a driving system that is able to modulate the direction, deceleration and acceleration of the vehicle under test in order to follow recorded trajectories with an accuracy of 50 cm when comparing recorded and replayed trajectory over time.

10 Pre-Test Submissions

Prior to commencement of testing, the OEM shall present to the Test Service evidence that the BSW system has been tested by an independent Test Service and shown to meet the performance requirements of UNECE Regulation No 151 – Alternative Test and UNECE Regulation No 159.

Test Evidence	Required Outcome	Outcome
UNECE Regulation No 151 – Alternative test	True	
UNECE Regulation No 159	True	
		Score (2 required)

11 Test Procedure

The bus and the pedestrian dummy shall initially be travelling on a parallel path. The bus will then make a turn towards the pedestrian dummy such that the front of the bus is inside the corridors defined by the red points on one of either envelope 4 or envelope 5 shown on the next pages and copied from UNECE Regulation No 151. Note that the continuous lines represent real trajectories recorded from test runs with real vehicles of different types and human drivers. The red points are subsequently added to define the corridor, based on incorporating all of those test runs, sometimes excluding one or two outliers.



Further note that the corridors defined for UNECE Regulation No 151 a are intended for left hand drive vehicles where a nearside turn is to the right. For the UK right hand drive market the trajectories are a mirror image created around a horizontal line with the y-axis co-ordinate of zero and reproduced below.

Envelope 4:

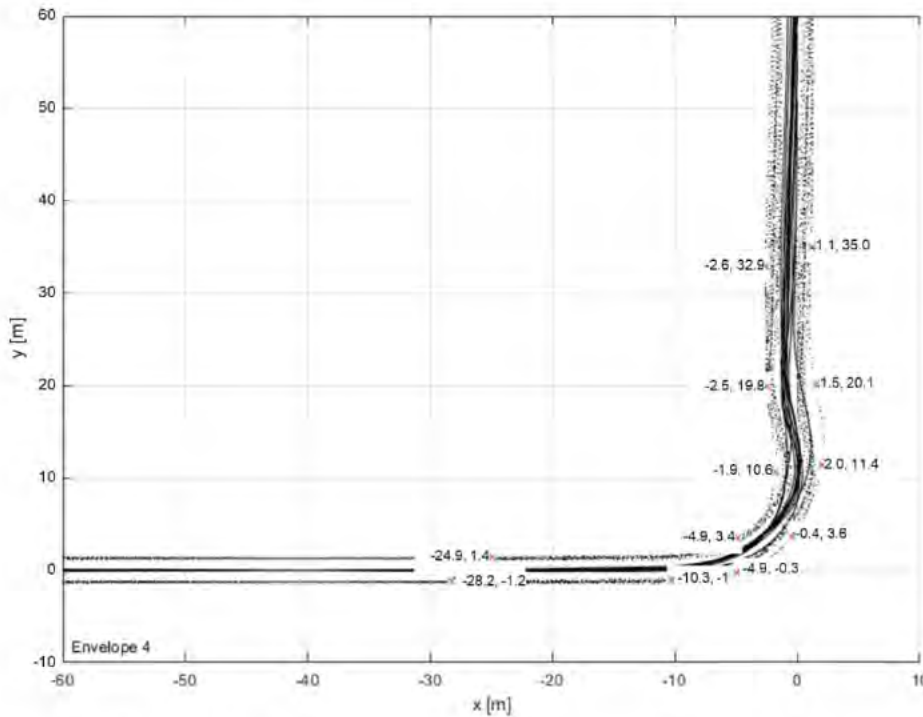

Envelope 5:

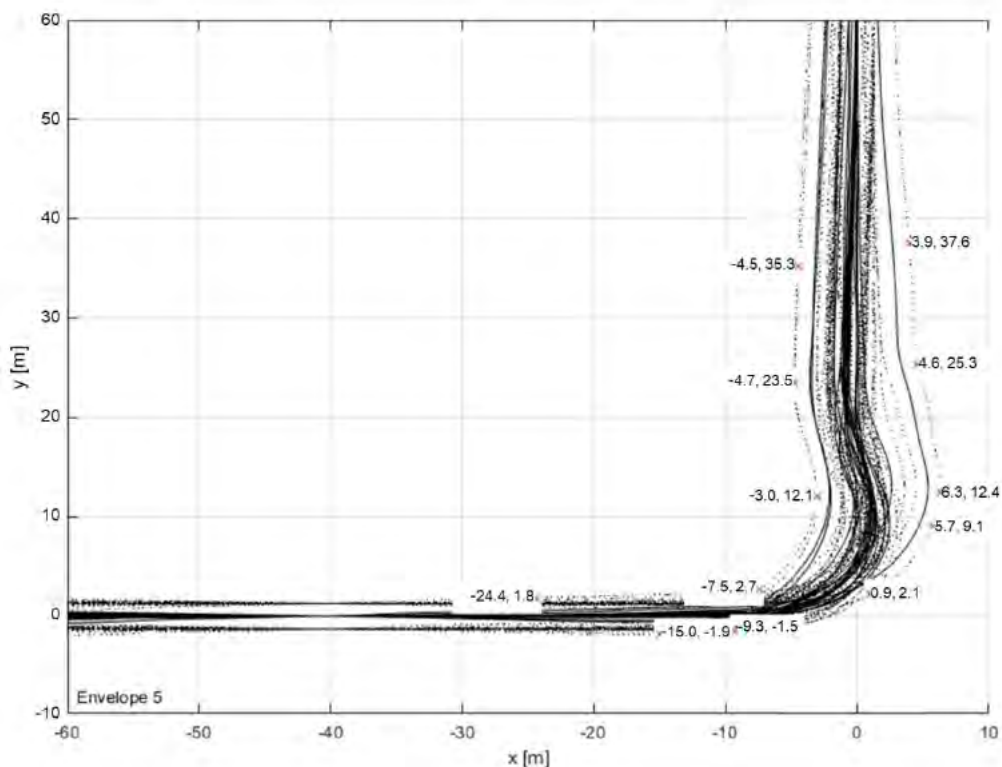



The origin of the pedestrian dummy (Test Target; EPT_a) local coordinate system shall move along a straight path in the global X-direction at a constant y-axis coordinate of +5.7m (± 0.1m). It shall start at an x-axis position of x=-15m and shall reach its nominal test speed of 5 km/h before it reaches the position of x=-12m. The instantaneous speed of the dummy after this point is permitted to vary by up to ± 2 km/h in order to enable synchronisation with the vehicle under test to achieve the intended impact position.

The bus shall be accelerated to the Initial test speed before the position x=-60m and this speed shall then be maintained constant (± 2 km/h) until a position of x=-30m is reached. The test manoeuvres shall first be driven manually by a human driver choosing a natural course that is representative of real world while complying with the limits specified. The speed is permitted to change after the point x=-30m is reached. No upper or lower limits are specified by drivers shall aim to produce a turn that they consider to be realistic and representative of a turn a driver might make in normal in-service use. The position and speed shall be constantly recorded. It is permitted but not required to mark the restriction points out on the test track using cones or similar markers.

The human driven trajectory recorded shall be repeated but this time using the driving control system to provide the vehicle inputs and to synchronise vehicle and pedestrian timing such that the two will meet at the defined impact position. The driving control system shall ensure that after the position of x=-30m is reached, the speed is matched to the human driven profile within a tolerance of ±1 km/h.

Tests shall be undertaken in each permutation of the following conditions:

- Impact Point
 - Front left corner of bus, to 0.5m to the rear of the front left corner
 - Between 5.5m and 6m to the rear of the front left corner of the bus
- Initial bus speed
 - 10 km/h
 - 20 km/h

The impact point shall be defined as the first moment that either the Pedestrian dummy (Test Target; EPT_a) frontal reference point or hip reference point would lie on a vertical plane aligned with the side of the bus. If the correct collision position for each VUT trajectory has been verified with a test run without a dummy on the carrier platform and repeatability of the test setup has been verified as well, the test may be aborted after detection of the information signal.

Calculate the stopping distance with respect to passing the Pedestrian trajectory for each individual trajectory and each available sampling point, taking into account a possible vehicle deceleration of 5 m/s² and a reaction time of 1.4 seconds.

The calculation may be performed in the following manner:

Calculate the required braking distance d_{brake} for each data point on the trajectory, using the following equation:

$$d_{brake,total}(t) = \frac{v(t)^2}{2 \cdot \frac{5m}{s^2}} + 1.4s \cdot v(t),$$

using the momentaneous vehicle speed $v(t)$ in m/s.



The distance of the VUT front nearside corner on its path to the Pedestrian line of movement shall be $d_{\text{Pedestriantrajectory}}(t)$.

The position of the last point of information then is given by the first time where the following condition applies:

$$|d_{\text{Pedestriantrajectory}}(t) - d_{\text{brake,total}}(t)| < 0.35 \text{ m}$$

The test procedure is considered to be passed if the information signal is given at a distance (on the path coordinate of the individual trajectories) greater than the stopping distance (on the path coordinate of the individual trajectories) as calculated above for all 8 scenarios (trajectory 4 or 5, with vehicle speed 10 or 20 km/h and impact point front or 6m to the rear).

Only one test is to be undertaken for each scenario.

[Optional addition: If a test condition results in a 'fail', and the manufacturer considers that the system should have passed then they may request a re-test of that point at their own expense. In this case, the manufacturer shall provide evidence as to why they think the test failed and can pass if in an additional 5 repeats of the scenario the requirement is always met]

The test report shall be annexed to the certificate.

12 Test Report

The Test Service shall provide a comprehensive Test Report that will be made available to TfL. The test report shall consist of three distinct sections:

- a) Performance data
- b) Confirmation of protocol compliance
 - Containing all measurement data (in the form of plots) and all calculations done. The time and distance to collision at which the information signal was activated shall be recorded and, if activated during the test, the timing of the collision warning shall also be recorded.
- c) Reference information

The reference information required includes as a minimum:

- a) Vehicle Make
- b) Vehicle Model
- c) Vehicle Model Variant
- d) BSW Hardware version (e.g. sensor types, ECU references)
- e) BSW Software version



Attachment 25: Blind Spot Warning

Guidance Notes

1 Introduction

The aim of the Blind Spot information signal, Warning and intervention (BSW) safety measure is to recognise that good vision alone will not guarantee that drivers will successfully avoid all collisions with VRUs in close proximity to buses performing low speed manoeuvres. Information signals, warnings and interventions based on the detection of vulnerable road users through electronic sensing systems can, therefore, still have a significant potential benefit in these circumstances. Separate requirements are intended to ensure that drivers have a good field of view from a bus in respect to vulnerable road users (VRUs) in close proximity to the bus. However, it also recognises that much of this warning function is now required to meet European type approval requirements and there are strong benefits to harmonisation of standards. As such, it only seeks to extend the performance of regulated functions in the one area which is most relevant to London's collision data – pedestrians injured by buses turning left – which is not in scope of the current regulations

This document sets out the guidance notes related to the testing and assessment of the safety performance of BSW systems. These guidance notes are aimed at bus operators and OEMs as a practical guide for implementation of the Bus Safety Standard.

These notes are for guidance only and are not legally binding. In all circumstances, guidance provided by the OEM or system supplier shall take precedence, and these guidance notes are only for use in the absence of other information. These are not intended to be exhaustive, but to point the operators toward practical advice and questions to raise with OEMs/suppliers.

2 Selection of buses/systems

Any bus that meets the TfL Bus Vehicle Specification.

The performance of systems may vary depending on the steering characteristics of the vehicle, among other things. As such, it is the vehicle that is approved against this requirement, not the blind spot information and warning system as a separate component. Regulations permitting component approval may be developed in future, and TfL may adapt its approach at that time if the net benefits of doing this are significant.



2.1 Compliance and warranty

A bus operator should ensure that these systems are covered by the OEM's warranty conditions

2.2 Interpreting the requirements and selecting the most effective way to fulfil them

In order to recognise a potentially dangerous situation during low-speed manoeuvres and successfully avoid a collision, then the following elements are required:

- **Available to be seen:** The hazard (pedestrian, cyclist, other vehicle etc.) needs to be available to be seen by the driver sufficiently ahead of time to allow avoiding action to be taken. That is, the hazard needs to be in view at least around 2 seconds before collision.
- **Alert and attentive:** The driver needs to be attentive to the road and traffic environment and alert to the possible need to react.
- **Looking in the right direction:** In complex driving situations, the driving task can demand attention in multiple different directions; the driver needs to be looking in the right direction at the right time to see the hazard. In dynamic moving environments this is not guaranteed even if the driver is alert and attentive.
- **Recognition:** Once the hazard is seen, then the driver must recognise the hazard and the risk that it poses.
- **Reaction:** Once the risk is recognised, the driver must react quickly and correctly to the risk. In some circumstances this may be steering around the hazard, in many it will be braking the vehicle to a stop and in others it might simply be to remain stationary instead of moving off from rest.

Thus, the ability to avoid a collision in the low-speed manoeuvring circumstances envisaged for BSW systems is also strongly related to the vision performance of the bus and so the two safety measures should be considered together so that they are complementary and work in synergy.

BSW systems can supplement the vision requirements in circumstances where the hazard is still unavailable to be seen by the driver. However, the main benefit is likely to be in drawing the driver's attention to the presence of the hazard when, either for legitimate reasons of driver workload or for reasons of distraction or fatigue, the driver is not looking in the direction of the hazard at the exact time needed to stop them making a turn and creating a collision risk, or if they have already started to turn, to brake and stop the vehicle to avoid collision or at least to reduce collision speed and/or the chances of a VRU being subsequently run over by the rear wheels of the bus as it cuts into an ongoing turn. In these circumstances the BSW can draw the driver attention to the right spot at the right time where the hazard will be visible in direct or indirect vision such that it maximises the chance of prompt recognition and correct reactions.

In order to achieve this, the way that the systems interact with the driver to inform them, warn them or intervene on their behalf is considered critical to the likely success of the system. This aspect of system design is known as the human-machine interface, or HMI. Measures are in place to encourage good HMI in the test



and assessment protocol and are based on established industry standards (e.g. ISO standards). They are typically related to the criticality of the driving situation (is a collision likely in the next couple of seconds, in a longer period or not necessarily likely at all) and the urgency of the warning. However, it can be very difficult to tightly regulate the HMI because people vary and the whole cab environment and all of its systems need to be considered to get a safe comfortable and effective HMI for the bus as a whole.

As such, OEMS and operators should aim to select BSW systems that integrate well in their specific vehicle and follow the guidance below to the greatest extent possible.

2.3 Proximity information signals

Proximity information signals are systems that will inform the driver any time a vulnerable road user is in close proximity to the vehicle. In London traffic these will be issued very frequently. In the vast majority of these situations, the situation will not be critical i.e. a collision will not be imminent in the next couple of seconds and the driver may well already be well aware of the presence of the hazard. The aim is to inform the driver that the VRU is there at a time when the driver can simply choose not to make the turn and to avoid the hazardous situation entirely. Thus, rapid reaction to non-critical situations should be discouraged and the warning should not be urgent or intrusive. In these circumstances an urgent, intrusive warning such as a loud tonal sound, a buzzer etc. can be annoying to the driver. They may subconsciously tune the warning out such that they ignore it when it is really needed or they may even find ways of disabling the system. Thus, examples of amber visual warnings may be much more acceptable to the driver in the many cases where the situation is not critical and/or they were already aware, while still providing useful information about the presence of hazards, when they are hidden or the driver has not seen them.

2.4 Collision warnings

Collision warnings should be issued only when the driving situation is critical i.e. the system has calculated that a collision is imminent in the next few seconds. Thus, even in London traffic they should go off far less frequently than proximity warnings. Situations only become that critical when the driver starts to turn towards the VRU. In this case, it is necessary for the warnings to be urgent and intrusive because they must quickly grab the attention of the driver and provoke rapid action to prevent a collision. These intrusive warnings are far less likely to annoy the driver, firstly because they should be far less frequent than proximity warnings and secondly because if they are working well it should be possible for the driver to see the reason for the warning in the majority of instances. False or premature activations when either the system has misdiagnosed the situation or reacted too soon will undermine driver confidence in the system and should be minimised, though what constitutes 'too soon' or even 'false' is to some degree subjective and driver dependent.

As such warnings issued over more than one channel (e.g. audible and visual and/or haptic warnings that are felt such as vibrations) are desirable, and speech warnings are undesirable because they take a finite time to complete and the drivers take a finite amount of time to process and understand the warning. Visual warnings should



be red and audible warnings sufficiently loud to be heard against the backdrop of engine/passenger noise etc.

2.5 Other alert/warning signals

It should be noted that the test and assessment protocol only considers information signals and collision warnings in relation to close proximity manoeuvring but system suppliers may offer such signals in other driving circumstances, for example in relation to lane departure or imminent collision with a vehicle ahead. The requirements of the Bus Vehicle Specification and the test and assessment protocol do not apply to these other functions but also do not prohibit them. You can have other functions on the vehicle if considered beneficial. However, operators should consider the same HMI principles in relation to these other warnings and consider driver workload, recognition and reaction issues in terms of how well the system communicates the type of hazard to the driver such that it maximises the chance of a quick and correct response and avoids driver confusion. Having very similar anonymous bleeps in reaction to multiple different undesirable traffic situations is unlikely to maximise driver effectiveness in collision avoidance. This is the reason the main body of the LBSL Bus Vehicle Specification (Section 4.3.4.5) applies a maximum audible warning frequency. This maximum remains a very high level compared with modern passenger cars and operators should try to favour systems that pass these requirements with a lower frequency of audible warning.

2.6 Signal directionality and workload

Systems that draw the driver's attention in the direction of the hazard are considered more desirable than those that do not. For example, a system detecting the proximity of a cyclist to the left of the bus might illuminate an amber visual warning at the left side of the bus. By contrast a system that issues an audible and visual collision warning at a point low down in the dashboard near the driver, actually draws driver attention away from the hazard and may well be less effective as a consequence and generally increase driver workload.

Buses are now required to replace external mirrors with camera monitor systems compliant with UN Regulation No 46. The use of overlays within the monitors of those systems as the HMI for BSW during a nearside turn is thought to be a very effective way of drawing the attention of the driver to the place where the hazard can be seen. It may also be a way for reducing the workload involved in responding appropriately to the warning because they do not need to look at a separate warning interface before looking for the hazard.

TfL would encourage operators to consider systems using this and are examining whether this should become a mandatory requirement in future

2.7 Intervention systems

Even with the best vision and a high quality warning, successful collision avoidance will still rely on the driver taking the correct course of action sufficiently quickly and is, therefore, not guaranteed. Intervention systems will act in the event that the driver does not make the correct avoidance action or makes it insufficiently quickly. There are also clear risks with intervention systems if, for example, they misdiagnose the



situation and intervene when they should not. At least one production AEB that is effective in nearside turns is available in the HGV market. 'Motion Inhibit' that stops the vehicle from moving off from rest if a VRU is directly in front of it in an impact position is a relatively simple concept but is not yet in production in any market.

TfL sees the benefits of such systems and will explore how the market can best be stimulated to provide effective systems on buses in the future.

3 Training

3.1 For test houses

Test houses accredited to undertake UN ECE Regulation No 151/UN ECE regulation No 159 and/or Euro NCAP AEB tests will have the skills and equipment required for these tests. Test houses without such accreditation will be required to demonstrate to TfL at their expense that they can achieve the same standard of testing as an accredited organisation.

3.2 Bus drivers

Drivers should be familiarised with the system such that they know what any warnings mean. They should also be trained to understand the circumstances where the system can help them and those where it cannot, for example, if a system does not perform at night or in adverse weather. If the OEM recommends actions to keep sensors clean for example, then drivers should also be trained to include examination of the sensors as part of walk around checks and to undertake any simple cleaning required. If any more complex action is required, they should refer to maintenance staff.

3.3 Shift Supervisors

The engineers carrying out general bus maintenance should be aware of the location and details of the sensors and warning displays/tell tales. They should be trained in any routine maintenance required (e.g. keeping sensors clean, free from obstruction etc.), how to fault find and repair the system itself, and also any limitations or requirements that the system places on other maintenance tasks. For example, the presence of a radar sensor in a bumper may require that the bumper must be replaced rather than repaired if damage occurs in the vicinity of the sensor. A camera mounted on the inside of a window may need a software recalibration if the window is replaced.

3.4 Bus maintenance engineers

The engineers carrying out general bus maintenance should be aware of the location and details of the sensors and warning displays/tell tales. They should be trained in any routine maintenance required (e.g. keeping sensors clean, free from obstruction etc.) and how to fault find and repair the system.



4 Maintenance

Operators are encouraged to establish what (if any) daily checks are required, and to plan for these additional operational costs.



Attachment 26: Pedal Application Error

Assessment Protocol

1 Introduction

This document presents a procedure for objectively assessing the performance of systems designed to stop incidents of pedal application error from occurring and to aid recovery from pedal application error.

For full understanding of this Attachment it should be read in conjunction with the New Bus Specification, Section 4.3.5.2, Section 4.3.5.3 and Attachment 27 – Pedal Application Error Guidance Notes

2 Scope

This protocol applies to all new buses intended for service under contract to TfL that are passenger vehicles with a maximum mass exceeding 5 tonnes and a capacity exceeding 22 passengers. The passenger vehicles will be capable of carrying seated but unrestrained occupants and standing occupants. Such vehicles are categorised the Consolidated Resolution on the Construction of Vehicles (R.E.3) as M₃; Class I.

The pedal acoustic feedback assessment shall only apply to quiet running buses with a hybrid (HEV), pure electric (PEV), electrified vehicle (EV), fuel cell vehicle (FCV) or a fuel cell hybrid vehicle (FCHV) drivetrain.

3 Purpose

The purpose of this assessment is to provide data from a controlled and repeatable test that can be used to assess the potential benefits (reduced casualties and damage) of a system to minimise pedal application error incidents, namely:

- The misapplication of the accelerator pedal; or
- The failure of the drivers to realise that they have applied the incorrect pedal.

In addition to measuring aspects of vehicle dynamics, the protocol provides a method for measuring how the system affects driver performance and how drivers interact with and understand the system.

4 Normative references

The following normative documents, in whole or in part, are referenced in this document and are indispensable for its application. For dated references, only the edition cited applies. For undated references, the latest edition of the referenced document (including any amendments) applies.

- London Bus Services Limited New Bus Specification: Section 4.3.5.2
- London Bus Services Limited New Bus Specification: Section 4.3.5.3



- London Bus Services Limited New Bus Specification: Attachment 27 – Pedal Application Error Guidance Notes
- UNECE Regulation No, 121 - Uniform Provisions Concerning the Approval of: Vehicles with Regard to the Location and Identification of Hand Controls, Tell-tales and Indicators
- ISO 2575:2004 – Road Vehicles – Symbols for controls, indicators and tell-tales.
- NHTSA Human Factors Design Guidance for Driver-Vehicle Interfaces (DOT HS 812 360).

5 Definitions

For the purpose of this Protocol:

- **ALS: Accelerator Light System** – a light system to inform the driver which pedal is currently being pressed.
- **Approval Authority** – the body within TfL that certifies that a bus is approved for use in the TfL fleet and assigns its score under the Bus Safety Standard for use in procurement processes.
- **BTS: Brake Toggle System** – a system that requires an extra brake press in order to release the halt brake after the bus passenger doors have opened or the passenger ramp has been extended.
- **CAN bus: Controller Area Network bus** – a vehicle bus standard to allow communication between microcontrollers and devices in applications without a host computer.
- **Halt Brake** – an automated braking system that prevents a bus from moving under certain conditions (e.g. when the bus passenger doors are open or the bus ramp is extended).
- **New Build** – a vehicle that has been built by the OEM with the system to be assessed fitted during the assembly process prior to first registration of the vehicle.
- **OEM: Original Equipment Manufacturer** - The company responsible for the manufacture of a completed bus, delivered to a bus operator
- **Pedal Acoustic Feedback System** – a system fitted on quiet running buses that provides an acoustic feedback to the driver as to the acceleration and change of speed of the bus as determined by pedal usage, in order to help the driver recover from a pedal application error incident.
- **Pedal Application Error** – an incident where a driver mistakenly presses the accelerator pedal instead of the brake pedal.
- **Retrofit** – fitment of the system to be assessed after the first registration of the vehicle. Installation is to be completed by the OEM or an authorised fitter.
- **Test Service** – The organisation undertaking the testing and certifying the results to the Approval Authority.



- **VUT: Vehicle Under Test** – means a vehicle that is being tested to this protocol.

6 Test conditions

6.1 Test Track

Testing shall be conducted on solid-paved road surfaces, with only a small amount of surface moisture, ice or other environmental factors that could reduce surface adhesion permitted.

The road surface shall be a uniform, solid-paved surface with a consistent slope in any direction of between 0% and 1%, and not contain any major irregularities such as large pot holes or cracks in the road surface that may affect the behaviour of the driver (e.g. forcing them to take avoiding action) or have a physical impact on them (e.g. disturbing their foot and body position by causing them to move around excessively in their seat).

There shall be no obstructions in front of or behind the VUT for a distance of 10m. There shall be an area of free space of 3m to either side of the VUT.

6.2 Weather and lighting

Testing shall be conducted in weather conditions such that testing can be safely conducted at the discretion of the Test Service and temperatures no lower than 5°C and not higher than 40°C.

Testing shall be conducted in the following lighting conditions:

- a) Ambient illumination shall be homogenous in the test area and in excess of 2000 lux. Testing shall not be performed driving towards, or away from the sun when there is direct sunlight.

7 Vehicle preparation

The VUT shall be prepared according to the following requirements:

The pedal application error systems shall have been installed during manufacture in the case of a new-build vehicle or retrofitted by qualified fitter authorised by the OEM; and

The VUT shall:

- a) Have passed a DVSA approved Periodic Technical Inspection within the last 12 months (if the vehicle is more than 12 months old) or passed an equivalent inspection if unregistered
- b) Be within its scheduled maintenance period (unless it is a new vehicle that has not yet been required to have its first service)
- c) Have no faults or damage that could interfere with the testing protocol
- d) Have a Halt Brake system that engages when the bus passenger doors are opened and when the passenger ramp is extended or the bus is kneeling
- e) Be driven by a qualified driver



Be empty of passengers or any persons other than the driver and required qualified test personnel.

8 Test procedure

8.1 Brake Toggle System

Apply the Brake Toggle System checklist as defined in Appendix A for both Drive and Reverse gears in the following sequence:

- a) Put the VUT into the specified state
- b) Execute step action and observe the result
- c) Compare the observed result to required result
- d) Record if observed result matches required result (“Pass” or “Fail”)

Note: Bus state refers to whether the vehicle ‘ignition’ is on, and the vehicle is in a driveable state.

8.2 Accelerator Light System

Apply the Accelerator Light System checklist as defined in Appendix B in the following sequence:

- a) Put the VUT into the specified state
- b) Execute step action and observe the result
- c) Compare observed result to required result
- d) Record if observed result matches required result (“Pass” or “Fail”)

The assessment of the ALS shall be completed under the following lighting conditions:

- a) Daylight

See section 6.2 for definition of lighting conditions.

Apply the lamp installation/illumination checklist as defined in Appendix C

The activation time of the lamps shall be assessed using high speed video analysis.

- a) The frame rate for the video shall be at least 30 frames per second.
- b) The high-speed video shall be synchronised with the CANBus signal from the pedals.

The delay between the first movement of the pedal and the lamp achieving 90% of its steady state output shall be recorded.

Note: Bus state refers to whether the vehicle ‘ignition’ is on, and the vehicle is in a driveable state.



8.3 Pedal Acoustic Feedback

The Pedal Acoustic Feedback specification and assessment protocol are both currently under development by TfL. At this time system suppliers and OEMs are encouraged to engage with TfL for programme updates, future performance requirements and implementation dates.

This test shall only apply for quiet running vehicles including a hybrid (HEV), pure electric (PEV), electrified vehicle (EV), fuel cell vehicle (FCV) or a fuel cell hybrid vehicle (FCHV) drivetrain.

9 Assessment of Results

The following criteria will be used to assess if the Brake Toggle System and Accelerator Light System have passed or failed the assessment.

9.1.1 Brake Toggle System

In order to receive a “Pass” certification the system must receive a “Pass” grade for each of the requirements in the Drive and Reverse assessment checklists in Appendix A.

The system shall be deemed to have failed the assessment if it received a single “Fail” grade in the Drive or Reverse assessment checklists in Appendix A.

9.1.2 Accelerator Light System

In order to receive a “Pass” certification the system must receive a “Pass” grade for each of the requirements in the Accelerator Light System assessment checklist in Appendix B.

The system shall be deemed to have failed the assessment if it received a single “Fail” grade on the Accelerator Light System assessment checklist in Appendix B.

9.1.3 Lamp Installation/illumination Checklist

In order to receive a “Pass” certification the system must receive a “Pass” grade for each of the requirements on the assessment checklist in Appendix C .

The system shall be deemed to have failed the assessment if it received a single “Fail” grade on the assessment checklist in Appendix C.

The lamp activation time shall be 100ms or less.

9.1.4 Pedal Acoustic Feedback Checklist

The Pedal Acoustic Feedback specification and assessment protocol are both currently under development by TfL. At this time system suppliers and OEMs are encouraged to engage with TfL for programme updates, future performance requirements and implementation dates.



9.1.5 Overall Assessment

In order to receive an overall “Pass” certification the system must receive a “Pass” grade for each of the above sections on the checklist and have a lamp activation time of 100ms or less.

The system shall receive an overall “Fail” grade in the assessment if a single “Fail” grade was awarded on any section of the assessment checklist or if the lamp activation time is more than 100ms.

To integrate this pass/fail test into the overall bus safety score an overall Pass will be deemed as a score of 100% and a fail will be deemed a score of 0%.

10 Test report

The Test Service shall provide a comprehensive test report that will be made available to the Approval Authority. The test report shall consist of the following distinct sections:

- a) Completed Brake Toggle System checklist;
- b) Completed Accelerator Light System checklist;
- c) Completed lamp installation/illumination checklist;
- d) Lamp activation assessment;
- e) Pedal Acoustic Feedback checklist; and
- f) Reference information.

The reference information required shall include as a minimum:

- a) Vehicle make;
- b) Vehicle model;
- c) Vehicle model variant;
- d) Pedal application error system installed (New-build/Retrofit);
- e) Evidence of meeting vehicle preparation requirements (e.g. MOT certificate, service history);
- f) Details of the Test Service; and
- g) Test date(s).



Appendix A - Brake Toggle System checklist – Drive and Reverse Scenarios

Step	Bus State (On/Off)	Gear	Park Brake	Bus Passenger Doors	Action	Required Outcome	Actual Outcome	Outcome match? (Yes=1, No=0)
1	On	Drive	On	Closed	Open any bus passenger doors	Halt brake engages		
2	On	Drive	Off	Open	Close bus passenger doors and then depress accelerator	Halt brake remains engaged, and bus remains stationary		
3	On	Drive	Off	Closed	Depress brake pedal to level that triggers brake lights on, and then release brake pedal	Bus remains stationary.		
4	On	Drive	Off	Closed	Apply accelerator > 10% AND ≥ 10s after completing Step 3	Bus remains stationary		
5	On	Drive	Off	Closed	Depress brake pedal to level that triggers brake lights on, then release brake pedal and apply accelerator ≤ 10s after releasing brake pedal	Bus moves forward (The vehicle must remain stationary regardless of vehicle orientation against track gradient until Step 5 Action is completed correctly)		
Bring Vehicle to Rest using Foot Brake								
6	On	Drive	Off	Closed	Open any bus passenger doors	Halt brake engages		
7	On	Drive	Off	Open	Close bus passenger doors and then depress brake pedal to level that triggers brake lights on, then release brake pedal and apply accelerator ≤ 10s after releasing brake pedal	Bus moves forward (The vehicle must remain stationary regardless of vehicle orientation against track gradient until Step 7 Action is completed correctly)		
							Total Required Score Outcome	7

Transport for London
London Buses

New Bus Specification Version 2.5



Step	Bus State (On/Off)	Gear	Park Brake	Bus Passenger Doors	Action	Required Outcome	Actual Outcome	Outcome match? (Yes=1, No=0)
1	On	Reverse	On	Closed	Open any bus passenger doors	Halt brake engages		
2	On	Reverse	Off	Open	Close bus passenger doors and then depress	Halt brake remains engaged, and bus remains stationary		
3	On	Reverse	Off	Closed	Depress brake pedal to level that triggers brake lights on, and then release brake pedal	Bus remains stationary.		
4	On	Reverse	Off	Closed	Apply accelerator > 10% AND ≥ 10s after completing Step 3	Bus remains stationary		
5	On	Reverse	Off	Closed	Depress brake pedal to level that triggers brake lights on, then release brake pedal and apply accelerator ≤ 10s after releasing brake pedal	Bus moves backwards (The vehicle must remain stationary regardless of vehicle orientation against track gradient until Step 5 Action is completed correctly)		
Bring Vehicle to Rest using Foot Brake								
6	On	Reverse	Off	Closed	Open any bus passenger doors	Halt brake engages		
7	On	Reverse	Off	Open	Close bus passenger doors and then depress brake pedal to level that triggers brake lights on, then release brake pedal and apply accelerator ≤ 10s after releasing brake pedal	Bus moves forward (The vehicle must remain stationary regardless of vehicle orientation against track gradient until Step 7 Action is completed correctly)		
Total Required Score Outcome								7



Appendix B - Accelerator light system checklist

Step	Bus State (On/Off)	Gear	Park Brake	Bus Doors	Action	Required Outcome	Actual Outcome	Outcome match? (Yes=1, No=0)
1	On	Drive	Off	Closed	Neither pedal pressed	Light is unlit when neither pedal is pressed		
2	On	Drive	Off	Closed	Brake pedal pressed	Light is unlit when brake pedal is pressed		
3	On	Drive	Off	Closed	Accelerator pedal pressed <80%	Light unlit		
4	On	Drive	Off	Closed	Accelerator pedal pressed >80%	No noticeable delay in light turning on		
5	On	Drive	Off	Closed	Accelerator pedal pressed >80%	Light illuminated		
6	On	Drive	Off	Closed	Accelerator pedal pressed <80%	No noticeable delay in light turning off		
7	On	Drive	Off	Closed	Accelerator pedal pressed >80%	No visible flickering of lights		
8	On	Drive	Off	Closed	Brake pedal pressed	No noticeable delay in light turning off		
9	On	Drive	Off	Closed	Accelerator pedal pressed	No noticeable delay in light illuminating		
Total Required Score Outcome								9



Appendix C - Lamp installation/illumination checklist

Step	Bus State (On/Off)	Gear	Park Brake	Bus Doors	Action	Required Outcome	Actual Outcome	Outcome match? (Yes=1, No=0)
1	On	Neutral	On	Closed	Accelerator pedal pressed ≥80%	Lights meet requirements of UN Regulation 121 Sections 5.2.2 5.2.4 5.4.2 and 5.4.3		
2	On	Neutral	On	Closed	Accelerator pedal pressed ≥80%	Lights meet requirements of ISO 2575:2004 Section 4 and Section 5		
3	On	Neutral	On	Closed	Accelerator pedal pressed ≥80%	Lights meet UN ECE Regulation 121		
4	n/a	n/a	n/a	n/a	n/a	The light symbol is: 		
5	n/a	n/a	n/a	n/a	n/a	The icon must be displayed on a minimum pixel matrix of 32x32.		
Total Required Score Outcome								5





Attachment 27: Pedal Application Error

Guidance Notes

1 Introduction

This document sets out the guidance notes related to pedal application error. These guidance notes are aimed at bus operators and OEMs as a practical guide for implementation of the Bus Safety Standard.

These notes are for guidance only and are not legally binding. In all circumstances, the guidance provided by an OEM or system supplier shall take precedence, and these guidance notes are only for use in the absence of other information. These are not intended to be exhaustive, but to point the operators toward practical advice and questions to raise with OEMs/suppliers.

For full understanding of this Attachment it should be read in conjunction with the New Bus Specification, Section 4.3.5.2, Section 4.3.5.3, Section 4.3.5.4, Section 4.3.7 and Attachment 26 – Pedal Application Error Assessment Protocol

2 Selection of buses/systems

Any bus that meets the TfL Bus Vehicle Specification.

The Bus Safety Standard contains several systems intended to reduce the likelihood and consequence of errors in pedal choice between the brake and accelerator:

- Pedal toggling – a system in which the brake pedal must be fully depressed and released before moving off after closing the doors
- Accelerator light indicator– a system that gives the driver a visual indication of the accelerator pedal being pressed via a light on the dashboard
- Pedal acoustic feedback system – a system that gives the driver an audible cue as to the use of pedals and the change of acceleration of the bus, in order to help with recovery from a pedal confusion incident.

2.1 Brake toggling

2.1.1 *Bus selection*

In order for this system to be retrofitted onto buses, the buses must have a halt brake system that operates when the bus passenger doors are opened (as well as when the passenger ramp is extended or the bus is kneeling). Therefore, vehicles with such a system should be procured.



2.1.2 System Selection

A brake toggling system that requires the driver to press the brake pedal in order to release the halt brake should be selected. The halt brake should only engage after the bus passenger doors have been opened or the passenger ramp has been extended or the bus is kneeling, with the brake toggling to release the halt brake only intended to operate when drivers are leaving bus stops or starting their shift. A comparison between the task order for the brake toggle system and standard bus operation is detailed in Table 27_1 and Table 27_2 below, for when the vehicle is left in Drive or taken out of Drive.

Table 27_1. Comparison of task order between standard operation and the brake toggle system – vehicle left in gear - D (drive)

Standard Bus Task Order	Brake Toggle Task Order
Open passenger door/ extend ramp/kneel bus – halt brake on	Open passenger door/ extend ramp/kneel bus – halt brake on
Close passenger door/retract ramp/raise bus – halt brake remains on	Close passenger door/retract ramp/raise bus – halt brake remains on
	Release park brake - halt brake remains on
	Press brake - halt brake remains on
Release park brake – halt brake remains on	Release brake - halt brake remains on
Apply accelerator to release halt brake and move off	Apply accelerator ≤ [10] seconds of releasing brake to release halt brake and move off



Table 27_2. Comparison of task order between standard operation and the brake toggle system – vehicle taken out of gear-D

Standard Bus Task Order	Brake Toggle Task Order
Open passenger door/ extend ramp/kneel bus – halt brake on	Open passenger door/ extend ramp/kneel bus – halt brake on
Close passenger door/retract ramp/raise bus – halt brake remains on	Close passenger door/retract ramp/raise bus – halt brake remains on
Press brake - halt brake remains on	Release park brake - halt brake remains on
Change gear to “D” – halt brake remains on	Press brake - halt brake remains on
Release brake - halt brake remains on	Release brake - halt brake remains on
Release park brake – halt brake remains on	
Apply accelerator to release halt brake and move off	

Note: if the Standard Bus Task Order differs for the scenario in Table 27_2, then the Brake toggle Task Order in Table 27_1 shall be implemented.

2.2 Brake/accelerator indicator lights

2.2.1 Bus selection

It may be easier to integrate the accelerator light into buses with LCD screens on the dashboard.

2.2.2 System selection

The accelerator indicator light system should be designed in such a way that it conforms to UN ECE Regulation 121. This makes reference to ISO 2575:2004, which should be used as additional guidance if needed. If further guidance is still needed then the guidance set out in the NHTSA Human Factors Design Guidance For Driver Vehicle Interfaces (DOT HS 812 360) may be referenced as a third option. UN ECE Regulation 121 takes precedence in all cases.

The requirements for the design and installation of the accelerator light system are contained within the requirements of the EC Whole Vehicle Type Approval for any tell-tale or indicator fitted to passenger or goods vehicles. These are provided in UN ECE Regulation 121 - Uniform Provisions Concerning the Approval of: Vehicles with Regard to the Location and Identification of Hand Controls, Tell-tales and Indicators. Regulation 121 prescribes the location, identification, colour, and illumination of common controls as well as the requirements for access and visibility

The visual indicator showing the driver when the accelerator is pressed is not included within the list of common items or controls covered by the Regulation.



Where a tell-tale or indicator for which the Regulation does not provide specific provisions is installed on a vehicle certain, requirements shall be adhered to. These requirements, taken from Sections 5 and 6 of Regulation 121, are summarised below:

Identification:

- a) Where possible a symbol designated for the purpose in ISO 2575:2010 - Road vehicles — Symbols for controls, indicators and tell-tales, shall be used
- b) To identify a tell-tale or indicator not included in the Regulation or ISO 2575:2004 the OEM may use a symbol of its own conception. Such symbols may include internationally recognised alphabetic or numeric indications.
- c) Where a symbol is designed by an OEM the principles of Paragraph 4 of ISO 2575:2010 shall be followed.
- d) Any additional symbol used by the OEM shall not cause confusion with any symbol specified in the Regulation.

Colour:

- a) Indicators and tell-tales not included in the Regulation or ISO 2575:2010 may be of any colour chosen by the OEM, however, such colour shall not interfere with or mask the identification of any tell-tale, control, or indicator specified in the Regulation.
- b) The colour to be selected shall follow the guidelines specified in Paragraph 5 of ISO 2575:2010.
- c) Each symbol used for identification of tell-tale or indicator shall stand out clearly against the background.
- d) The accelerator light system selected must adhere to these criteria.

2.3 Pedal acoustic feedback

2.3.1 Bus selection

This system is only required on quiet running buses with a hybrid (HEV), pure electric (PEV), electrified vehicle (EV), fuel cell vehicle (FCV) or a fuel cell hybrid vehicle (FCHV) drivetrain.

2.3.2 System Selection

No prototype or production versions of this system yet exist. Consultation with the OEMs and TfL is needed before selecting buses.

3 Training

Usage of the pedal confusion solutions will require the creation of a training course to teach drivers about the solutions and how they operate. If feasible schedules should minimise drivers experience of mix of vehicles with and without the system. The determination for whether or not a driver is able to safely use the systems shall



be up to the discretion of the bus operator and any assessment criteria they decide upon.

3.1 Brake Toggle

As the brake toggle solution involves a change to the driving tasks that drivers will have been trained to undertake and may have used for extended periods of time, some form of training with the system will be necessary.

In order to train drivers to use the brake toggle solution, it is recommended that drivers are first given a set of written instructions that explain how the system operates. The drivers shall then be given an oral explanation of how the system works from an instructor who is experienced at using the system. The driver shall then be given the opportunity to practise driving the bus on a private road. The driver shall first practice moving the bus from a standstill, imitating letting passengers on and off the bus by opening the bus doors and lowering the passenger ramp. Once the driver is comfortable using the system, they shall be given the opportunity to drive the bus on public roads. Ideally they will drive their normal bus route, stopping at bus stops along the way to practise moving off with the new brake interlock.

The instructor shall be responsible for determining if the driver is able to use the system based on how many errors they make and how long it takes them to deactivate the halt brake and drive away from the bus stops. There shall also be a small written examination that asks the driver basic questions regarding the brake toggle system, what the driver needs to do to operate the system and how their driving tasks will differ from what they are used to as a result of the system.

3.2 Accelerator Light System

Drivers are to be trained with the accelerator light system in conjunction with the brake toggle system, with the same training protocol applied. As with the brake toggle system, written and oral instructions will be provided to drivers, who will then drive the bus on private and public roads in order to familiarise themselves with the system. The instructor will then determine if the driver is able to safely use the system based on the number of errors they make and the time it takes them to move off from bus stops. A short written examination will also be employed to determine how well the driver understands the system.

3.3 Pedal acoustic feedback

The training for this system can be integrated with the other systems as above, with the same training protocol applied.

4 Maintenance

Maintenance shall only be undertaken by authorised and qualified individuals using OEM approved procedures. Maintenance of the systems should be incorporated into the regular servicing schedules for the bus.



4.1 Brake Toggle System

Maintenance of the brake toggle system consists of maintaining the software that controls the bus interlock system as well as the halt brake system.

The software that is responsible for operating the bus interlock system must be regularly checked as part of the regular vehicle service schedule. The software must be checked in order to see that the halt brake is only activated upon the opening of the bus doors or the lowering of the passenger ramp, and that the halt brake can only be released after the brake has been fully depressed. It must also be ensured that any software updates that are made to the bus do not alter the logic of the interlock system by allowing the halt brake to activate and deactivate in an incorrect manner. In order to ensure that the brake toggle system works as intended, the halt brake itself must undergo regular checks as part of the service schedule for the bus.

A maintenance check for the brake toggle system should consist of checking that opening the bus doors and lowering the passenger ramp activates the halt brake, and that the halt brake cannot be deactivated without the brake pedal being fully depressed. A software check should also be carried out in order to ensure that the system is operating correctly.

4.2 Accelerator Light System

Maintenance of the accelerator light system should form part of the regular service schedule for the vehicle.

The light must be checked to see that there is no visible flicker when it illuminates and that there is no perceptible delay between the accelerator pedal being pressed and the corresponding lights activating. The light should also be checked to make sure that the correct colour is associated with the accelerator pedal press. A check should also be made to see that the light does not illuminate when neither of the pedals are being pressed. If the light is built into an LCD display then the software that operates the screen must be regularly checked. Visual inspections must also be carried out in order to ensure that there are no dead pixels or artefacts.

A maintenance check for the accelerator light system should consist of a visual inspection of the lights while the accelerator pedal is being pressed. A software check should also be carried out.

4.3 Pedal acoustic feedback system

Maintenance of the pedal acoustic feedback system should form part of the regular service schedule for the vehicle.

The speakers must be checked to see that there is no obscuration or damage, and to check that there is no perceptible delay between the accelerator pedal being pressed and the corresponding sound changing frequency. A check should also be made to listen for the sound changing frequency as the accelerator pedal is released, and that the sound remains constant if the pedal pressure is also constant.



5 Repair

Repairs shall only be undertaken by authorised and qualified individuals using OEM approved parts and procedures. If the systems were retrofitted then the guidelines set out by the post-homologation OEM shall be followed.

Advice should be sought from the supplier of the specific systems fitted to buses in service regarding precautions to be taken in the event of a system failure. However, as these systems are safety aids rather than safety critical systems for the bus, the failure of these systems should not normally render the bus unroadworthy. Repairs to the systems should be made as soon as operationally possible.

5.1 Brake Toggle System

If a failure occurs to the brake toggle system due to a software error, then an appropriate software fix shall be implemented. The OEM (or post-homologation parts manufacturer in the case that the systems were retrofitted) should be consulted to diagnose the software fault and they shall then issue a fix to resolve the fault. The bus operator should not attempt to diagnose and fix the issue without consulting the bus OEM and seeking their assistance as incorrect software changes could affect the functioning of the halt brake.

Any faults that occur with halt brake system shall be repaired following the normal repair guidelines set out by the bus OEM.

5.2 Accelerator Light System

In the event that the accelerator light system becomes faulty due to a software issue then the OEM (or post-homologation parts manufacturer) should be consulted to diagnose the software fault and they shall then issue a fix to resolve the fault. Any physical issues with the lights shall be resolved by replacing the lights with approved parts. If the operation of dashboard lights fitted within an LCD screen is compromised due to some fault with the screen itself, e.g. dead pixels, poor contrast or brightness, then the bus OEM or supplier of the screen should be consulted for repair instructions.

5.3 Pedal acoustic feedback system

In the event that the pedal acoustic feedback system becomes faulty due to a software issue then the OEM (or post-homologation parts manufacturer) should be consulted to diagnose the software fault and they shall then issue a fix to resolve the fault. Any physical issues with the speakers shall be resolved by replacing the speakers with approved parts.



Attachment 28: Runaway Bus Prevention Assessment Protocol

1 Introduction

A Runaway Bus Prevention system is required for all buses in service in London to automatically stop the bus from moving from a stationary position in the event that a driver has left the driving seat without applying the park brake.

This document presents a procedure for objectively assessing the performance of systems installed on a bus to prevent the bus rolling in an uncontrolled manner without input from a driver; the occurrence of which would be known as a “runaway event” or a “runaway bus”.

For full understanding of this Attachment it should be read in conjunction with the Attachment 29: Runaway Bus Prevention Guidance Notes and New Bus Specification, Section 4.3.6 and Section 5.2.

Supporting documents are located on the [TfL BVS Database HERE](#). These documents will help in the understanding, developing and testing of Runaway Bus Prevention Systems.

2 Scope

This protocol applies to all new buses intended for service under contract to TfL that are passenger vehicles with a maximum mass exceeding 5 tonnes and a capacity exceeding 22 passengers. The passenger vehicles will be capable of carrying seated but unrestrained occupants and standing occupants. Such vehicles are categorised the Consolidated Resolution on the Construction of Vehicles (R.E.3) as M₃; Class I.

3 Purpose

The purpose of this protocol is to allow an assessment against the required level of performance for systems that intend to prevent runaway bus occurrences.

4 Normative References

The following normative documents, in whole or in part, are referenced in this document and are indispensable for its correct application. For dated references, only the edition cited applies. For undated references, the latest edition of the referenced document (including any amendments) applies.

- London Bus Services Limited New Bus Specification: Section 4.3.6
- London Bus Services Limited New Bus Specification: Section 5.2
- [Runaway Bus Prevention Supporting Documents](#)



- London Bus Services Limited New Bus Specification: Attachment 29 Runaway Bus Prevention Guidance Notes

5 Definitions

For the purpose of this Protocol:

- **Approval Authority** – The body within TfL that certifies that a bus is approved for use in the TfL fleet and assigns its score under the Bus Safety Standard for use in procurement processes
- **Halt Brake** – An automated braking system that prevents a bus from moving under certain conditions (e.g. when the bus doors are open or the bus ramp is lowered)
- **New Build** – A vehicle that has been built by the OEM with the system to be assessed fitted during the assembly process prior to first registration of the vehicle
- **Park Brake** – Brake system that is intended to keep the vehicle stationary when parked
- **RaB: Runaway Bus** – A bus without the park brake engaged that moves in any direction in an uncontrolled manner without any input from a driver
- **RaBPS: Runaway Bus Prevention System** - The system implemented in conjunction with the Park Brake to prevent a Runaway Bus scenario
- **RaBPS_{TT}** - Runaway Bus Trigger Time; the time taken for RaBPS to apply the Park Brake once Trigger conditions have been met
- **Test Mark** – Start point/position of front wheels of VUT at beginning of each test, used to measure roll distance
- **Test Service** – The organisation undertaking the testing and certifying the results to the Approval Authority
- **Trigger Conditions** - Conditions where the driver is deemed to be NOT present, causing RaBPS to apply the Park Brake
- **VUT: Vehicle Under Test** – The vehicle tested according to this protocol



6 Test conditions

6.1 Test track

Testing shall be conducted on solid-paved road surfaces, with only a small amount of surface moisture, ice or other environmental factors that could reduce surface adhesion permitted. It shall be at the discretion of the Test Service to determine whether the Test Track surface conditions allow testing.

There are 3 different gradients that are to be used for testing as per Appendix B:

1. For 'flat' tests, the Test Track gradient shall be <1%
2. For positive and negative gradient tests, the Test-Track shall have a gradient of between 1% and 3%
3. For Worst Case tests, the test track gradient shall be 20%

A clear zone shall be defined around the VUT. The clear zone shall extend at least one bus length in front and one bus length behind the VUT, and one bus width to either side of the VUT. This is to give sufficient room for any rolling that occurs as a result of the testing.

6.2 Weather and lighting

Testing shall be conducted in weather conditions such that testing can be safely conducted at the discretion of the test service and temperatures no lower than -5°C and not higher than 40°C

The test track shall have a level of ambient light that will allow the driver and assessor to see if any people or objects move into positions where they could be at risk of being hit by the bus during testing.

7 Vehicle preparation

The RaBPS shall:

- a) Have been installed during manufacture of the VUT

The VUT shall:

- a) Have passed its mandatory Periodic Technical Inspection at a DVSA approved facility within the last 12 months (if the vehicle is more than 12 months old), with the exception of prototype vehicles
- b) Be within its scheduled maintenance period (unless it is a new vehicle that has not yet been required to have its first service)
- c) Have no faults or damage that could interfere with the testing protocol. The brakes shall have been checked by the driver to ensure that the bus can be stopped manually during testing in the event that the bus does roll
- d) Have a halt brake system the engages when the bus passenger doors are opened, when the passenger ramp is extended or the bus kneels
- e) Have checked all bus passenger doors to ensure they are all fully operational



- f) Be positioned on the test track of defined gradient to ensure that if the bus is not being held stationary by any mechanisms it will visibly roll in a way that is obvious to the assessor
- g) Have no obstructions in front or behind any of its wheels
- h) Be driven by a qualified driver. In the instances where the test procedure requires there be no seat pressure the driver shall remain within the drivers cabin to apply the brakes when the bus rolls
- i) Be empty of passengers or any persons other than the driver and required qualified test personnel

NOTE: the OEM shall ensure that all monitored Primary and Secondary signals are made available for logging by the Test Service at a suitably high raster in order to determine Runaway Bus Prevention System Trigger Time (RaBPS_{TT})

As a minimum the OEM shall supply:

- A relevant .dbc file, that shall enable the Test Service to monitor and record the CANBus channels used for Primary and Secondary Driver Detection Input signals
- Locations of all required physical take off/measurement points to the Test Service for accessing and connecting logging equipment to the CANBus

8 Test Procedure

The assessment of the RaBPS is carried out in two stages. The Auxiliary Release system checklist shall be completed prior to commencing the RaBPS checklist.

Assessments shall be conducted and recorded for:

- For vehicles without a creep function, 18 tests, chosen at random by the Test Service, with a minimum of 2 tests chosen per test section from sections 1-9
 - Note: Section 9 tests are conducted on a 20% gradient. These tests shall only be conducted if all other previous tests have been undertaken and achieved a Pass
- If the vehicle is determined to have a creep function, it shall undergo a further test, selected at random by the Test Service from Section 10 for a total of 19 tests completed

NOTE: If any test is failed, then the OEM has 2 options:

1. Provided the OEM **DOES NOT** make any changes to the RaBPS then:
 - a. The failed test shall repeated
 - b. The remaining tests shall be completed
 - c. A further 9 tests, chosen by the Test Service, made up of 1 test not yet tested per test section from sections 1-9, shall also be completed
 - d. The Section 9 Tests shall be completed
2. If the OEM makes ANY changes to the RaBPS, then a full retest shall be undertaken as per the test procedure above.



8.1 Auxiliary Release System Checklist

Apply the Auxiliary Release system checklist as defined in Appendix A in the following sequence:

- a) Put the VUT into the specified state and gear
- b) Execute the actions for the requisite step and observe the result
- c) Compare the observed result to the required result
- d) Record if observed result matches required result (“Pass” or “Fail”)
- e) Reset the position of the VUT if it has moved during the test
- f) Reset the gear to neutral

Note: Bus state refers to whether the vehicle ‘ignition’ is on, and the vehicle is in a driveable state.

8.2 RaBPS checklist

Only if all requirements of the Auxiliary Release system checklist are satisfied shall the testing continue. Apply the RaBPS checklist as defined in Appendix B in the following sequence:

Stationary Tests (Test Matrix Test Section 1, 2 & 8; Runaway Bus scenario)

- a) Ensure the vehicle is on (ignition ON, vehicle can drive)
- b) Put the vehicle into the specified gear as per the Test Number selected at random by the test service
- c) Drive the vehicle as per the relevant gear (forwards for Drive, in reverse for Reverse) so that the front wheel is aligned with the with the test mark
- d) Keep foot brake depressed, do NOT apply the Park Brake
- e) Trigger RaBPs according to the relevant Trigger number for that test (Trigger ‘i’ see note below)
- f) Record results and if observed result matches required result (“Pass” or “Fail”)

Note: Refer to Section 4.3.6.3 – System Hierarchy, Point 4 for details of ‘RaBPs Trigger’

Note: For Section 8 tests, the Test Track gradient must be 20%

Stationary Tests (Test Matrix Test Section 6; Runaway Bus – Vehicle Shut Off scenario)

- a) Ensure the vehicle is on (ignition ON, vehicle can drive)
- b) Put the vehicle into the specified gear as per the Test Number selected at random by the test service



- c) Drive the vehicle as per the relevant gear (forwards for Drive, in reverse for Reverse) so that the front wheel is aligned with the with the test mark
- d) Keep foot brake depressed, do NOT apply the Park Brake
- e) While remaining in the driver's cab and driver's seat, take all necessary steps to switch the vehicle off (vehicle shutdown)
- f) Record results and if observed result matches required result ("Pass" or "Fail")

Note: Refer to Section 4.3.6.3 – System Hierarchy, Point 2 for details of 'vehicle shutdown requirements

Dynamic Tests (Test Matrix Test Section 3, 4 & 5; Driver Misuse scenario)

- a) Switch the vehicle on
- b) Put the vehicle into the specified gear as per the Test Number selected at random by the test service
- c) Drive the vehicle as per the relevant gear (forwards for Drive, in reverse for Reverse), at the relevant speed
- d) Trigger RaBPs according to the relevant Trigger number for that test (Trigger 'ii' or 'iii', see note below)
- e) Record result and if observed result matches required result ("Pass" or "Fail")

Note: Refer to Section 4.3.6.3 – System Hierarchy, Point 4 for details of 'RaBPs Trigger'

False Positive Tests (Test Matrix Test Section 7; Driver Misuse scenario)

For this test, the Test Service shall begin and then abort either Trigger 'ii' or Trigger 'iii', selected at random and recorded by the Test Service, to ensure the RaBPs only triggers when all conditions are met.

- a) Switch the vehicle on
- b) Put the vehicle into the specified gear as per the Test Number selected at random by the test service
- c) Drive the vehicle as per the relevant gear (forwards for Drive, in reverse for Reverse), at the relevant speed
- d) Begin to Trigger RaBPs according to the relevant Trigger number for that test (Trigger 'ii' or 'iii', see note below)
- e) Abort triggering of RaBPs before Trigger Driver Detection Conditions are met
- f) Record result and if observed result matches required result ("Pass" or "Fail")

Note: Refer to Section 4.3.6.3 – System Hierarchy, Point 4 for details of 'RaBPs Trigger'

**Creep Tests (Test Matrix Test Section 9; Creep scenario)**

- a) Switch the vehicle on
- b) Put the vehicle into Drive
- c) Remove application of both footbrake and accelerator pedal and allow vehicle to 'creep'. Record the vehicle/'creep' speed
- d) Trigger RaBPs according to the relevant Trigger number for that test (Trigger 'i', see note below)
- e) Record observed results ("Pass" or "Fail")

Note: Refer to Section 4.3.6.3 – System Hierarchy, Point 4 for details of 'RaBPs Trigger'

Idle Shutdown Tests (Test Matrix Test Section 10; Idle Shutdown scenario)

- a) Switch the vehicle on
- b) Put the vehicle into Drive
- c) Trigger RaBPs according to the relevant Trigger number for that test (Trigger 'i', see note below)
- d) Wait 2.5 minutes
- e) Record observed results ("Pass" or "Fail")

Note: Refer to Section 4.3.6.3 – System Hierarchy, Point 4 for details of 'RaBPs Trigger'

9 Assessment of results

The following criteria will be used to assess if the RaBPS has passed or failed the assessment.

9.1 Assessment of the Auxiliary Release System

- a) In order to receive a "Pass" certification the system must meet the expected outcome when tested against each of the requirements on Appendix A - Auxiliary Release system assessment checklist.
- b) The system shall be deemed to have failed the assessment if it does not meet any single expected outcome in Appendix A.

9.2 Assessment of the RaBPS

- a) In order to receive a "Pass" certification the system must meet the expected outcome when tested, for each of the requirements of Appendix B – RaBPS Test Matrix.
- b) The system shall be deemed to have failed the assessment if it does not meet any single expected required outcome Appendix B – RaBPS Test Matrix.



9.3 Overall Assessment

- a) In order to receive an overall “Pass” certification the system must receive a “Pass” grade for each assessment.
- b) To integrate this pass/fail test into the overall bus safety score an overall Pass will be deemed as a score of 100% and a fail will be deemed a score of 0%
- c) A system that fails to meet these pre-requisites shall not be recommended

10 Test report

The Test Service shall provide a comprehensive test report that will be made available to the Approval Authority. The test report shall consist of three distinct sections:

- a) Completed Auxiliary Release system checklist
- b) Completed RaBPS checklist
- c) Vehicle Reference information

The reference information required shall include as a minimum:

1. Vehicle Make
2. Vehicle Model
3. Vehicle Model Variant
4. RaBPS installed
5. Evidence of meeting vehicle preparation requirements (e.g. MOT certificate, service history)
6. Details of the Test Service
7. Test date(s)



Appendix A - Auxiliary Release system checklist

Auxiliary Release			General Braking Mechanisms		Break Down	Expected Outcome	Actual Outcome	Outcome match? (Yes=1, No=0)
Bus State (On/Off)	Gear	Seat Pressure / Driver Input	Park Brake	Passenger Door	Auxiliary Release			
Off	Neutral	Yes	On	Closed	Disengaged	No roll		
Off	Neutral	No	Off	Closed	Engage	Roll		
On	Neutral	Yes	On	Closed	Disengaged	No roll		
On	Neutral	No	Off	Closed	Engage	Roll		
On	Reverse	Yes	On	Closed	Disengaged	No roll		
On	Reverse	No	Off	Closed	Engage	Roll		
On	Drive	Yes	On	Closed	Disengaged	No roll		
On	Drive	No	Off	Closed	Engage	Roll		
Total Required Score Outcome								8



Appendix B - Runaway Bus Prevention System Test Matrix

The full RaBPS test Matrix is located on the [TfL BVS Database HERE](#)

Section	Test Number	Test Procedure (RaBPS Scenario)	RaBPS trigger	RaBPS Condition	VUT Gear	Gradient	VUT Dynamic	Expected Outcome	RaBPS Trigger Delay (seconds)		Vehicle to Rest Time (seconds)		Measured Roll Distance (m) (for info)	Result (Pass/Fail)
									Target	Actual	Target	Actual		
1	1	Runaway Bus	i	Ideal	Neutral	Positive	Stationary	Application of RaBP	≤ 0.5	≤ 2				
	2	Runaway Bus	i	Ideal	Drive	Positive	Stationary	Application of RaBP	≤ 0.5	≤ 2				
	3	Runaway Bus	i	Ideal	Reverse	Positive	Stationary	Application of RaBP	≤ 0.5	≤ 2				
	4	Runaway Bus	i	Ideal	Neutral	Negative	Stationary	Application of RaBP	≤ 0.5	≤ 2				
	5	Runaway Bus	i	Ideal	Drive	Negative	Stationary	Application of RaBP	≤ 0.5	≤ 2				
	6	Runaway Bus	i	Ideal	Reverse	Negative	Stationary	Application of RaBP	≤ 0.5	≤ 2				
2	7	Runaway Bus	i	FailSafe	Neutral	Positive	Stationary	Application of RaBP	≤ 0.5	≤ 2				
	8	Runaway Bus	i	FailSafe	Drive	Positive	Stationary	Application of RaBP	≤ 0.5	≤ 2				
	9	Runaway Bus	i	FailSafe	Reverse	Positive	Stationary	Application of RaBP	≤ 0.5	≤ 2				
	10	Runaway Bus	i	FailSafe	Neutral	Negative	Stationary	Application of RaBP	≤ 0.5	≤ 2				
	11	Runaway Bus	i	FailSafe	Drive	Negative	Stationary	Application of RaBP	≤ 0.5	≤ 2				
	12	Runaway Bus	i	FailSafe	Reverse	Negative	Stationary	Application of RaBP	≤ 0.5	≤ 2				
3	13	Driver Misuse	ii	Ideal	Drive	Positive	Steady Speed ≤ 5.5 kph	Application of RaBP	≤ 0.5	≤ 2				
	14	Driver Misuse	iii	Ideal	Drive	Positive	Steady Speed ≤ 5.5 kph	Application of RaBP	≤ 0.5	≤ 2				
	15	Driver Misuse	ii	Ideal	Reverse	Positive	Steady Speed ≤ 5.5 kph	Application of RaBP	≤ 0.5	≤ 2				
	16	Driver Misuse	iii	Ideal	Reverse	Positive	Steady Speed ≤ 5.5 kph	Application of RaBP	≤ 0.5	≤ 2				
	17	Driver Misuse	ii	Ideal	Drive	Negative	Steady Speed ≤ 5.5 kph	Application of RaBP	≤ 0.5	≤ 2				
	18	Driver Misuse	iii	Ideal	Drive	Negative	Steady Speed ≤ 5.5 kph	Application of RaBP	≤ 0.5	≤ 2				
4	19	Driver Misuse	ii	Ideal	Reverse	Negative	Steady Speed ≤ 5.5 kph	Application of RaBP	≤ 0.5	≤ 2				
	20	Driver Misuse	iii	Ideal	Reverse	Negative	Steady Speed ≤ 5.5 kph	Application of RaBP	≤ 0.5	≤ 2				
	21	Driver Misuse	ii	Ideal	Drive	Flat	Steady Speed > 5.5 kph	Audible Alert	≤ 0.5					
	22	Driver Misuse	iii	Ideal	Drive	Flat	Steady Speed > 5.5 kph	Audible Alert	≤ 0.5					
	23	Driver Misuse	ii	Ideal	Reverse	Flat	Steady Speed > 5.5 kph	Audible Alert	≤ 0.5					
	24	Driver Misuse	iii	Ideal	Reverse	Flat	Steady Speed > 5.5 kph	Audible Alert	≤ 0.5					
5	25	Driver Misuse	ii	Ideal	Drive	Flat	Delta Speed: > 5.5 kph to ≤ 5.5 kph	Audible Alert then Application of RaBP	≤ 0.5	≤ 2				
	26	Driver Misuse	iii	Ideal	Drive	Flat	Delta Speed: > 5.5 kph to ≤ 5.5 kph	Audible Alert then Application of RaBP	≤ 0.5	≤ 2				
	27	Driver Misuse	ii	Ideal	Reverse	Flat	Delta Speed: > 5.5 kph to ≤ 5.5 kph	Audible Alert then Application of RaBP	≤ 0.5	≤ 2				
	28	Driver Misuse	iii	Ideal	Reverse	Flat	Delta Speed: > 5.5 kph to ≤ 5.5 kph	Audible Alert then Application of RaBP	≤ 0.5	≤ 2				
6	29	Runaway Bus	Vehicle Shut down (Vehicle 'key off')	Ideal	Neutral	Positive	Stationary	Application of RaBP OR Application of Park Brake by Driver	≤ 0.5	≤ 2				
	30	Runaway Bus	Vehicle Shut down (Vehicle 'key off')	Ideal	Drive	Positive	Stationary	Application of RaBP OR Application of Park Brake by Driver	≤ 0.5	≤ 2				
	31	Runaway Bus	Vehicle Shut down (Vehicle 'key off')	Ideal	Reverse	Positive	Stationary	Application of RaBP OR Application of Park Brake by Driver	≤ 0.5	≤ 2				
	32	Runaway Bus	Vehicle Shut down (Vehicle 'key off')	Ideal	Neutral	Negative	Stationary	Application of RaBP OR Application of Park Brake by Driver	≤ 0.5	≤ 2				
	33	Runaway Bus	Vehicle Shut down (Vehicle 'key off')	Ideal	Drive	Negative	Stationary	Application of RaBP OR Application of Park Brake by Driver	≤ 0.5	≤ 2				
	34	Runaway Bus	Vehicle Shut down (Vehicle 'key off')	Ideal	Reverse	Negative	Stationary	Application of RaBP OR Application of Park Brake by Driver	≤ 0.5	≤ 2				
7	41	False Positive	False Positive	False Positive	Drive	Flat	Steady Speed ≤ 5.5 kph	NO Action	∞					
	42	False Positive	False Positive	False Positive	Drive	Flat	Steady Speed > 5.5 kph	NO Action	∞					
	43	False Positive	False Positive	False Positive	Drive	Flat	Delta Speed: > 5.5 kph to ≤ 5.5 kph	NO Action	∞					
	44	False Positive	False Positive	False Positive	Reverse	Flat	Steady Speed ≤ 5.5 kph	NO Action	∞					
	45	False Positive	False Positive	False Positive	Reverse	Flat	Steady Speed > 5.5 kph	NO Action	∞					
	46	False Positive	False Positive	False Positive	Reverse	Flat	Delta Speed: > 5.5 kph to ≤ 5.5 kph	NO Action	∞					
	47	False Positive	False Positive	False Positive	Neutral	Flat	Steady Speed ≤ 5.5 kph	NO Action	∞					
	48	False Positive	False Positive	False Positive	Neutral	Flat	Steady Speed > 5.5 kph	NO Action	∞					
8	35	Runaway Bus	i	Worst Case	Drive	Positive	Stationary	Audible Alert then Application of RaBP	≤ 0.5	≤ 2				
	36	Runaway Bus	i	Worst Case	Drive	Negative	Stationary	Audible Alert then Application of RaBP	≤ 0.5	≤ 2				
	37	Runaway Bus	i	Worst Case	Neutral	Positive	Stationary	Audible Alert then Application of RaBP	≤ 0.5	≤ 2				
	38	Runaway Bus	i	Worst Case	Neutral	Negative	Stationary	Audible Alert then Application of RaBP	≤ 0.5	≤ 2				
	39	Runaway Bus	i	Worst Case	Reverse	Positive	Stationary	Audible Alert then Application of RaBP	≤ 0.5	≤ 2				
	40	Runaway Bus	i	Worst Case	Reverse	Negative	Stationary	Audible Alert then Application of RaBP	≤ 0.5	≤ 2				
9	50	Creep	i	Creep	Drive	Flat	Steady Speed ≤ 5.5 kph	Vehicle speed < 5.5 kph then Application of RaBP	≤ 0.5	≤ 2				
	51	Creep	ii	Creep	Drive	Flat	Steady Speed ≤ 5.5 kph	Vehicle speed < 5.5 kph then Application of RaBP	≤ 0.5	≤ 2				
	52	Creep	iii	Creep	Drive	Flat	Steady Speed ≤ 5.5 kph	Vehicle speed < 5.5 kph then Application of RaBP	≤ 0.5	≤ 2				
10	53	Idle Shutdown	i	Ideal	Drive	Positive	Stationary	Application of RaBPS then Idle Shutdown after 2.5 mins						
	54	Idle Shutdown	i	Ideal	Drive	Negative	Stationary	Application of RaBPS then Idle Shutdown after 2.5 mins						
	55	Idle Shutdown	i	Ideal	Reverse	Positive	Stationary	Application of RaBPS then Idle Shutdown after 2.5 mins						
	56	Idle Shutdown	i	Ideal	Reverse	Negative	Stationary	Application of RaBPS then Idle Shutdown after 2.5 mins						



Attachment 29: Runaway Bus Prevention Guidance Notes

1 Introduction

A Runaway Bus Prevention System (RaBPS) is required for all buses in service in London to automatically stop the bus from moving from a stationary position in the event that a driver has left the driving seat without applying the park brake.

This document sets out the guidance notes related to runaway bus prevention. These guidance notes are aimed at bus operators and OEMs as a practical guide for implementation of the Bus Safety Standard.

These notes are for guidance only and are not legally binding. In all circumstances, the guidance provided by an OEM or system supplier shall take precedence, and these guidance notes are only for use in the absence of other information. These are not intended to be exhaustive, but to point the operators toward practical advice and questions to raise with OEMs/suppliers.

2 Selection of buses/test services

Any bus that meets the TfL Bus Vehicle Specification.

An assessment of the RaBPS shall be conducted using a new build bus.

The testing of the RaBPS shall be carried out by a TfL approved test service

2.1 Compliance and warranty

A bus operator should ask to see compliance certificates for UNECE Regulation 13 and warranty information for the brake system from both the bus OEM and/or the system supplier. The bus operator must be able to present certificates to TfL as evidence that the bus brake system will continue to operate safely, and that the bus will not brake unexpectedly whilst in motion.

A bus OEM should work with any brake or runaway bus prevention system suppliers to ensure that UNECE Regulation 13 requirements are met, and that warranty on the brake system is maintained. The bus OEM must be able to present certificates to TfL as evidence that the bus brake system will continue to operate safely, and that the bus will not brake unexpectedly whilst in motion.

In the case that there are any functional changes made to the bus the vehicle should be re-tested (at the discretion of TfL) to make sure it still complies with the Runaway Bus Prevention Assessment Protocol (LBSL Attachment 28).



2.2 Towing and recovery

The RaBPS is designed to keep the bus brakes on. Towing and recovery are the exceptions to this requirement and the bus needs to be able to roll without the driver in the seat.

UNECE Regulation 13 requires an auxiliary release system for the brakes to allow towing. These are often mechanical. Auxiliary release is only intended for use in full breakdown/recovery circumstances and should only be undertaken when the vehicle is held stationary by some other external means, e.g. wheel chocks or recovery vehicles etc.. The Regulation permits powered auxiliary release systems but only if the energy source is different to that used by the brakes, e.g. it can't be operated from the same air supply such that the loss causing the problem also causes the release not to work. Bus drivers should be trained on how to use the auxiliary release.

3 Training

3.1 Bus drivers

The RaBPS are aimed at reducing the risk associated with the rare occurrences where the park brake has not been applied. The drivers don't necessarily need to be trained in exactly how the system works but do need to be informed that it will trigger in instances where the bus has been left vulnerable to rolling (without the park brake engaged). Drivers do however need to be trained in how to release the system once they have rectified the issue by engaging the park brake.

3.2 Shift Supervisors

Shift supervisors should be trained in how the system works and know the code/sequence of actions to activate the Runaway Bus Prevention system's auxiliary release.

In the event that the system has been engaged and the driver or engineer is not able to release it, the shift supervisor shall have ability to rectify the situation.

3.3 Bus maintenance engineers

The engineers carrying out general bus maintenance should be aware of how to activate the auxiliary release on the runaway prevention system, should the maintenance they are carrying out require the bus to roll whilst in a state where the runaway prevention system would otherwise inhibit that movement.

4 Maintenance

The supplier of the Runaway Bus Prevention System or the vehicle OEM are required to provide the operator with suitable instructions and schedules for required checks and maintenance activities.



Operators are to ensure instructions and schedules provided by the system supplier or OEM are incorporated into the vehicle maintenance plans along with any associated costs.

5 Repair

If during system maintenance checks (Section 4) any of the sensors are deemed to be faulty or failing they must be replaced immediately. The runaway prevention system's effectiveness and reliability is completely contingent on the performance of the sensors the system is connected to.



Attachment 30: Acoustic Conspicuity

Assessment Protocol

1 Introduction

This document presents a procedure for objectively assessing the performance of Acoustic Vehicle Alerting Systems (AVAS) installed on a bus. TfL has designed a unique Urban Bus Sound to be used by quiet running buses in London and buses belonging to other organisations at TfL's discretion.

The aim of these systems is to make a vehicle fitted with a quiet running powertrain (e.g. hybrid or electric) as conspicuous to a pedestrian as a typical diesel engine.

For full understanding of this Attachment it should be read in conjunction with the Attachment 31: Acoustic Conspicuity Guidance Notes and New Bus Specification, Section 4.4.1.

1.1 Description of System

The AVAS produces sound during both 'idle' (motor is on, but the vehicle is stationary) and while 'in-motion' vehicle operations, up to a maximum speed of 22 km/h.

The Urban Bus Sound comprises two separate sound elements, the 'Core' and 'Beacon'. The 'Core' sound plays during 'idle' and 'in-motion' operations. The 'Beacon' sound plays during 'in-motion' operation, in addition to the 'Core'.

The frequency, or pitch, of the AVAS sounds respond directly to the speed of the vehicle at a rate of 0.8% per km/h. This is informed via CAN bus messages.

The volume of the AVAS shall adapt based on CAN bus messages from the ISA (Responsive AVAS), unless ISA is not enabled (Non-Responsive AVAS), to achieve the requirements set out in Appendix B. The system manufacturer is responsible for setting the appropriate gain level and frequency profile (via a graphical equaliser or equivalent) to achieve the overall sound levels and frequency profile in Table 30_1, whilst the system is installed on vehicle. This should account for the sounder frequency response, sounder positioning and coverings.

1.1.1 Responsive AVAS (Geo-fencing)

The volume of the AVAS adapts based on the street quality and type where the vehicle is situated, as well as time of day (day or night), to improve audibility on busier streets and reduce disturbance on quieter streets or at night. This is informed by a map-based dataset that is managed by TfL and integrated into the Intelligent Speed Assistance (ISA) system database. Based on the GPS location of the vehicle, a specific CAN bus frame is sent to the AVAS (AVAS Step level values 1-4) to inform what volume level to operate. The AVAS Step level value shall be used to inform a gain level change in the AVAS unit to meet the required sound levels of Table 30_1



in this document. Further information on the Intelligent Speed Assistance (ISA) system is in LBSL Bus Vehicle Specification; Section 4.3.3 and LBSL Attachment 17: Intelligent Speed Assistance (ISA) Assessment Protocol.

1.1.2 Non-Responsive AVAS

For vehicles without ISA capability, the volume of the AVAS shall be set to a fixed AVAS Step level, set out in the Bus Vehicle Specification.

2 Scope

This protocol applies to all new buses intended for service under contract to TfL that are passenger vehicles with a maximum mass exceeding 5 tonnes and a capacity exceeding 22 passengers. The passenger vehicles will be capable of carrying seated but unrestrained occupants and standing occupants. Such vehicles are categorised under the Consolidated Resolution on the Construction of Vehicles (R.E.3) as M₃; Class I.

UNECE Regulation 138 as amended (UNECE Regulation 138 hereafter), requires the addition of an Acoustic Vehicle Alerting System (AVAS) on all new quiet running vehicles. The regulation came into effect for all new vehicle models of this type manufactured after 01/07/2019 and applies to all vehicles manufactured after 01/07/2021.

3 Purpose

The purpose of this protocol is to allow an assessment against the required level of performance for Acoustic Vehicle Alerting Systems (AVAS).

4 Normative References

The following normative documents, in whole or in part, are referenced in this document and are indispensable for its correct application. For dated references, only the edition cited applies. For undated references, the latest edition of the referenced document (including any amendments) applies.

- London Bus Services Limited New Bus Specification: Section 4.4.1
- London Bus Services Limited New Bus Specification: Section 4.3.3
- London Bus Services Limited New Bus Specification: Attachment 31 Acoustic Conspicuity Guidance Notes
- London Bus Services Limited New Bus Specification: Attachment 17: Intelligent Speed Assistance (ISA) Assessment Protocol
- UN ECE Regulation 138; Uniform provisions concerning the approval of Quiet Road Transport Vehicles with regard to their reduced audibility



5 Definitions

For the purpose of this Protocol:

- **Approval Authority** – The body within TfL that certifies that a bus is approved for use in the TfL fleet and assigns its score under the Bus Safety Standard for use in procurement processes.
- **AVAS** – Acoustic Vehicle Alerting System. This is the entire system including both hardware & firmware/software and the Urban Bus Sound when installed on a bus, as per UNECE Regulation 138.
- **AVAS Hardware** - Complete playback system used to reproduce the AVAS
- **AVAS Step Level** – Value between 1-4 that determines the sound output level of the AVAS sound, based on the GPS location.
- **Beacon sound** - Part of the Urban Bus Sound. A Distinct rhythmic pulse, intended to raise acoustic conspicuity.
- **Core sound** - Part of the Urban Bus Sound. An underlying sound component that is played continuously when the bus is in operation
- **Existing Fleet** – A vehicle that is quiet running and is installed with a pre-2022 version of the AVAS.
- **Front plane of the vehicle** - A vertical plane tangential to the leading edge of the vehicle.
- **Gain** – Amplification applied to an audio signal to increase or decrease sound pressure level output from sounder/s.
- **Idle** – Vehicle motor is on but the vehicle is stationary.
- **In-motion** – Vehicle is operating above 0 km/h.
- **Intelligent Speed Assistance (ISA)** – Through TfL the Digital Speed Map bus selects localised speed limits and AVS Step Level (1-4).
- **L_{MAX, FAST}** – The maximum sound pressure in a measurement, A-weighted, Fast time weighting.
- **L_{Aeq, 10 seconds}** – The equivalent continuous sound pressure level for a 10 second period, A-weighted.
- **L_{SIL}** – The Speech Interference Level of noise, calculated as the arithmetic mean of the L_{eq,10 seconds} in four octave bands 500 Hz, 1 kHz, 2 kHz and 4 kHz.
- **Moving operation** – AVAS operation when a vehicle is in motion (above 0 km/h). Core and Beacon sound operation.
- **New Build** – A vehicle that has been built by the Vehicle OEM with the system to be assessed fitted during the assembly process prior to first registration of the vehicle.
- **Non-Responsive AVAS** – An AVAS configuration that has a fixed sound output level and is non-dependent on location and time of day.
- **Quiet running vehicle** - Any vehicle which does not require the continuous operation of an internal combustion engine to propel the vehicle.



- **Rear plane of the vehicle** - A vertical plane tangential to the trailing edge of the vehicle.
- **Responsive AVAS** – An AVAS configuration that adapts its sound output level depending on the vehicles GPS location and time of day via ISA.
- **Retrofit** – A vehicle as defined in the TfL AVAS Retrofit Programme.
- **Sound Pressure Level (L_{pA})** - The sound pressure expressed in Decibels, A-weighted.
- **Test Service** – The organisation undertaking the testing and certifying the results to the Approval Authority.
- **Urban Bus Sound** - The uniquely identifiable AVAS sound designed and owned by TfL, consists of two components.
- **VUT: Vehicle Under Test** – Means a vehicle that is being tested to this protocol.

6 Test Conditions

Requirements for testing are as defined in UNECE Regulation 138. Full compliance can only be illustrated with the system installed on a vehicle

6.1 Test Track (Outdoors)

Testing shall be conducted on a dry surface, free from absorbing materials (powdery snow, or loose debris).

The test track shall meet the requirements of ISO 10844:2014.

6.2 Test Track (Indoors)

The test facility shall meet the requirements of ISO 26101:2012.

6.3 Weather and lighting

Testing shall be conducted in dry weather conditions with no precipitation, temperatures no lower than 5°C and not higher than 40°C.

Wind speed shall be less than 5 m/s. As an alternative the tests may be conducted indoors.

The test track shall have a level of ambient light that will allow the driver and assessor to see if any people or objects move into positions where they could be a risk of being hit by the bus during testing.



7 Vehicle preparation

The AVAS shall have been installed during manufacture in the case of a new-build vehicle.

The VUT shall:

- a) Have passed an annual MOT test at a DVSA test station within the last 12 months (if the vehicle is more than 12 months old), with the exception of prototype vehicles
- b) Be within its scheduled maintenance period (unless it is a new vehicle that has not yet been required to have its first service)
- c) Have no faults or damage that could interfere with the testing protocol
- d) Be driven by a qualified driver. In the instances where the test procedure requires there be no seat pressure the driver shall remain within the drivers cabin to apply the brakes when the bus rolls
- e) Be empty of passengers or any persons other than the driver (or qualified test service personnel if required for testing)

8 Test procedure

The assessment of the AVAS is to be carried out using the checklist found in Appendix A.

The AVAS checklist shall be assessed based on documentation submitted by the bus OEM.

Testing of the AVAS shall be conducted in a manner conforming to UNECE Regulation 138, meeting both minimum UNECE Regulation 138 requirements as well as enhanced requirements set out in Appendices B and C.

The calculation procedure for assessment of compliance in relation to sound pressure levels is set out in Appendix D.

All observed results shall be recorded in the checklist.

9 Assessment of results

The following criteria will be used to assess if the AVAS system has passed or failed the assessment.

In order to receive a “Pass” certification, the system must meet the expected outcome for each of the requirements on the assessment checklist.

The system shall be deemed to have failed the assessment if it does not meet any single expected outcome on the AVAS assessment checklist. A system that fails to meet these pre-requisites shall not be recommended.



10 Test report

The Test Service shall provide a comprehensive test report that will be made available to the Approval Authority. The test report shall consist of two distinct sections:

- a) Completed AVAS checklist;
- b) Reference information.

The reference information required shall include as a minimum:

- a) Vehicle Make
- b) Vehicle Model
- c) Vehicle Model Variant
- d) AVAS system installed (including unit serial number)
- e) Evidence of meeting vehicle preparation requirements (e.g. technical inspection, service history)
- f) Evidence of meeting AVAS Sound Level Requirements for each Step level, as per Appendix B
- g) Details of the Test Service
- h) Test date(s)



Appendix A - AVAS checklist

Acoustic Vehicle Alerting System (AVAS)	Expected Outcome	Actual Outcome	Outcome match? (Yes=1, No=0)
Sounder/s located on the front of the vehicle below the windshield	True		
Sounders positioned in the direction of travel and not obstructed by any solid covering (New Build vehicles only)	True		
TfL Urban Bus Sound is in appropriate format	True		
The AVAS has a working functionality self-check with driver notification, informing that the AVAS and associated CAN bus messages are functional	True		
The AVAS sound is UNECE Regulation 138 compliant, and a valid test certificate submitted	True		
The reversing requirement of UNECE Regulation 138 is compliant	True		
The AVAS sound achieves all overall and third octave frequency band sound pressure levels for each AVAS Step as defined in Appendix B with a tolerance of ± 1.5 dB (Step 3 only, if Non-Responsive operation), and test documentation illustrating compliance provided	True		
The AVAS defaults to AVAS Step 3 in absence of ISA CAN-frame messages	True		
The AVAS sound does not exceed the maximum sound pressure levels in the Driver's cabin as defined in Appendix C for each AVAS operation	True		
The AVAS unit number is recorded in relation to the vehicle number and can receive local updates	True		
The AVAS can receive an updated sound file in the future	True		
Total			
Required Score			11
Outcome			



Appendix B – AVAS Sound Level Requirements

Measurement Positions: Front panes (left and right) – 2 meters from front centre (UNECE Regulation 138 front positions)

Vehicle Speed Operation: Performances shall be achieved at all speed operations below 22 km/h.

Measurement Setup: Tests may be carried out while the vehicle is stationary, simulating speed operation.

All overall and third octave frequency band sound pressure levels shown in Table 30_1 for AVAS Steps 1-4 shall be achieved within a tolerance of ± 1.5 dB (calculation procedure set out in Appendix D), in addition to minimum requirements of UNECE Regulation 138.

Gain settings for each AVAS Step are to be set by the AVAS supplier and shall respond to the associated CAN-frame AVAS Step message from the ISA system (unless ISA capability is not included, therefore 'Non-Responsive AVAS' requirements apply).

To achieve the enhanced requirements in Table 30_1 it is considered likely to require adjustments to the overall gain setting and frequency profile of the Urban Bus Sound according to the sounder frequency response, sounder positioning and coverings. This is the responsibility of the system manufacturer to adjust until the requirements of Table 30_1 are achieved.

The frequency profile in Table 30_1 may be subject to updates to respond to improvements in weatherproof sounder performance and improve fidelity of the Urban Bus Sound operating across the TfL bus fleet.



Vehicle Speed Operation: Performances shall be achieved at all speed operations below 22 km/h, tested as per Regulation 138.

Frequency (Hz)		A-weighted Sound Pressure Level ($L_{MAX, FAST}$ (dB))			
		AVAS Step 1	AVAS Step 2	AVAS Step 3	AVAS Step 4
Overall amplitude		60	63	66	69
1/3 Octave bands	160	25	28	31	34
	200	31	34	37	40
	250	30	33	36	39
	315	50	53	56	59
	400	47	50	53	56
	500	42	45	48	51
	630	51	54	57	60
	800	51	54	57	60
	1,000	51	54	57	60
	1,250	51	54	57	60
	1,600	45	48	51	54
	2,000	44	47	50	53
	2,500	44	47	50	53
	3,150	47	50	53	56
	4,000	36	39	42	45
5,000	26	29	32	35	

Table 30_1: Sound pressure level requirements in overall and third octave band (within ± 1.5 dB tolerance) for each the AVAS Step.



Appendix C – Cabin Sound Level Requirements

Drivers Cabin

Measurement Position: 1.2m above the cab floor, directly between the steering wheel and the driver's seat.

Frequency (Hz)	Sound Pressure Level ($L_{Aeq,10 \text{ second}}$ (dB))
	Maximum
New Build vehicles	55 (45 L_{SIL})
Existing Fleet and Retrofit vehicles	60 (50 L_{SIL})

Table 30_2: Maximum sound levels in the Drivers Cabin as a result of AVAS Sounder operation only.

Manufacturers are encouraged to further reduce the level of sound ingress to the Cabin from the AVAS sounders by system configuration, placement, equipment, sound insulation, or other means, below the maximum levels set out in Table 30_2.

*It should be noted that the maximum ingress levels set out above are sound contributions from AVAS Sounder only and should not include other sound contributions due to other equipment and/or garage activity. Garage activity noise conditions may limit the certainty of the contribution of the AVAS Sounder in isolation, and therefore the limits above are intended to be a sense check to raise any concern of excessive levels due to the AVAS Sounder ingress.



Appendix D – Calculation Procedure

The calculation procedure outlined in UNECE Regulation 138 Annex 3 paragraphs 3.4 and 3.5 shall be used to determine both minimum UNECE Regulation 138 requirements and the enhanced requirements in Appendix B of this document (Table 20_1).

The procedure is reproduced below for clarity:

Measurements & Reporting

- The A-weighted sound pressure level and corresponding one-third-octave band spectra shall be measured and reported for each measurement position and operational mode (i.e. 10 km/h, 20 km/h, etc).
- Measurements shall be reported to the first significant digit after the decimal place, i.e. XX.X).
- A minimum of four valid measurements for each operational mode are to be conducted. A valid measurement is determined by achieving four A-weighted sound pressure level measurements that are within 2.0 dB(A) of each other. This is to ensure consistency of measurements and to avoid erroneous readings caused by external activity noise or equipment. Each measurement position shall achieve this criterion individually.

Calculation of Assessment Values

- An arithmetic average of the four valid A-weighted and one-third-octave band spectra shall then be calculated for each measurement position and operational mode.
- The final A-weighted sound pressure level for each operational mode is the lower arithmetic average of the two measurement positions
- The final one-third-octave band sound pressure level spectra for each operational mode is that associated with the final A-weighted sound pressure level (i.e. lower value of the two measurement positions).

Assessment

To comply with the enhanced AVAS requirements in Appendix B of this document, the final A-weighted sound pressure level and all one-third-octave band spectra results shall be within ± 1.5 dB of the values in Table 30_1 for each AVAS Step level (1-4) for each operational mode. The ± 1.5 dB tolerance is intended to allow for a degree of flexibility in relation to achieving the spectra levels.

NB: To achieve the enhanced requirements in Table 30_1 it is considered likely to require adjustments to the overall gain setting and frequency profile of the Urban Bus Sound according to the sounder frequency response, sounder positioning and coverings. This is the responsibility of the system manufacturer to adjust until the requirements of Table 30_1 are achieved.



Attachment 31: Acoustic Conspicuity

Guidance Notes

1 Introduction

This document sets out the guidance notes related to Acoustic Conspicuity. These guidance notes are aimed at bus operators and OEMs as a practical guide for implementation of the Bus Safety Standard.

These notes are for guidance only and are not legally binding. In all circumstances, the guidance provided by an OEM or system supplier shall take precedence, and these guidance notes are only for use in the absence of other information. These are not intended to be exhaustive, but to point the operators toward practical advice and questions to raise with OEMs/suppliers.

2 Selection of buses/systems

2.1 Buses requiring Acoustic Conspicuity measures

Regulatory requirements are in force for Whole Vehicle Type Approval (WVTA), in the form of UNECE Regulation 138¹. This requires:

- From September 2019 all new bus models (new designs requiring type approval) in vehicle category
- M3 and fitted with either a hybrid (HEV), pure electric (PEV), electrified vehicle (EV), fuel cell vehicle (FCV) or a fuel cell hybrid vehicle (FCHV) drivetrain will be subject to having acoustic conspicuity measures installed.
- From September 2022 all new registered buses with drivetrains listed above will also be subject to having acoustic conspicuity measures installed.

TfL requires all new buses conforming to the description above, to have an Acoustic Vehicle Alerting System (AVAS) installed in accordance with UNECE Regulation 138.

In particular the AVAS shall additionally meet some extra requirements, mainly around ability to emit the urban bus sound being designed by TfL, and that the noise should be updatable in the future.

¹ UN ECE Regulation 138; Uniform provisions concerning the approval of Quiet Road Transport Vehicles with regard to their reduced audibility.



2.2 Acoustic Conspicuity Measure

2.2.1 AVAS (Acoustic Vehicle Alerting System)

A solution has been defined as 'added sound', or what is currently referred to as an AVAS (Acoustic Vehicle Alerting System). This is an audible warning, active at low speed, indicating steady state acceleration and deceleration conditions. Currently, systems meeting Regulation 138 are required to active at speeds between 0 km/h to 22 km/h inclusive, and are intended to replace engine noise cues to pedestrians and vulnerable road users (VRUs) that a vehicle is approaching.

The sound sources should be installed at the front of the bus such that they provide a fuller directional component towards the kerbside (see Bus specification 4.4.1.5 for details of source height and direction). This should also be done in conjunction with the supplier of the AVAS equipment.

TfL have developed a specific sound file which the vehicle will be required to generate, known as the Urban Bus Sound (UBS). Availability of the UBS will be provided by TfL upon request.

Vehicles using AVAS shall be shown to be compliant with UNECE Regulation 138 (Uniform provisions concerning the approval of Quiet Road Transport Vehicles with regard to their reduced audibility - QRTV). UNECE Regulation 138 lays out the requirements for the minimum sound and defines the testing protocol.

The frequency content of the Urban Bus Sound must increase and decrease as the bus accelerates and decelerates, at a rate of 0.8% per km/h.

The values defined in 'Attachment 30, Appendix B - AVAS Minimum Sound Level Requirements' are TfL's minimum requirements for the playback of the Urban Bus Sound. TfL would encourage innovation and seek suppliers to develop AVAS sounders that exceed these minimum requirements to produce an enhanced low frequency presence and detailed high frequency to reproduce the highest quality Urban Bus Sound and have supplied ideal values in 'Attachment 30, Appendix C Ideal Sound Level Requirements.'

3 Training

Once AVAS equipment is installed, there should be very little training required as the system is automatic and will operate between set speeds and adjust the sound for acceleration and deceleration via inputs from the CAN-Bus. However, individual suppliers of the equipment will advise if any training is required.

4 Maintenance

Once AVAS equipment is installed, there should be minimal maintenance required. However, as the system will be fitted within the front of the bus, regular inspection of the sound sources is recommended to keep them free of debris and to ensure that no damage has occurred.

Individual manufacturers of the equipment will advise if and what maintenance is required and will specify maintenance intervals.



5 Repair

Any repairs that are required to the AVAS will need to be done in conjunction with the supplier of the equipment.



Attachment 32: Slip Prevention Assessment Protocol

1 Introduction

To reduce the risk to occupants of slips or falls whilst travelling the floor of all buses in service in London will be expected to be covered with materials which provide an effective level of resistance to slip.

This document presents a procedure for the characterisation of the slip resistance properties of flooring materials for buses.

For full understanding of this Attachment it should be read in conjunction with the Attachment 33: Slip Prevention Guidance Notes and New Bus Specification, Section 4.5.6.

2 Scope

This protocol applies to all new buses intended for service under contract to TfL that are passenger vehicles with a maximum mass exceeding 5 tonnes and a capacity exceeding 22 passengers. The passenger vehicles will be capable of carrying seated but unrestrained occupants and standing occupants. Such vehicles are categorised the Consolidated Resolution on the Construction of Vehicles (R.E.3) as M₃; Class I.

3 Purpose

The purpose of this assessment is to characterise the slip risk associated with bus flooring materials by measuring and assessing the slip resistance of those materials. This is achieved by using a method adapted from the United Kingdom Slip Resistance Group (UKSRG) guidelines (The UK Slip Resistance Group, 2016) which uses the Portable Slip Resistance Tester (PSRT) as the measurement device.

4 Normative References

The following normative documents, in whole or in part, are referenced in this document and are indispensable for its correct application. For dated references, only the edition cited applies. For undated references, the latest edition of the referenced document (including any amendments) applies.

- London Bus Services Limited New Bus Specification: Section 4.5.6
- London Bus Services Limited New Bus Specification: Attachment 32 Slip Prevention Guidance Notes
- British Standards Institution. (2002). *BS 7976-2:2002 Pendulum testers - Part 2: Method of operation*. London: BSI.



- British Standards Institution. (2011). *BS EN 13036-4. Road and airfield surface characteristics. Test methods. Method for measurement of slip/skid resistance of a surface. The pendulum test*. London: BSi.
- British Standards Institution. (2013). *BS 7976-1:2002+A1:2013 Pendulum testers - Part 1: Specification*. London: BSi.
- British Standards Institution. (2013). *BS 7976-3:2002+A1:2013 Pendulum testers - method of calibration*. London: BSi.
- The UK Slip Resistance Group. (2016). *The assessment of floor slip resistance - The UK slip resistance group guidelines*. UKSRG.

5 Definitions

For the purpose of this Protocol:

- **Approval Authority** – The body within TfL that certifies that a bus is approved for use in the TfL fleet and assigns its score under the Bus Safety Standard for use in procurement processes.
- **IRHD: International Rubber Hardness Degrees** – Method for measuring the hardness of rubber.
- **PSRT: Portable Slip Resistance Tester** – Standard laboratory testing device for measuring slip resistance in the UK, defined by British Standards.
- **PTV: Pendulum Test Value** – Measurement recorded by the PSRT
- **UKAS: United Kingdom Accreditation Service** – The UK's national accreditation body.
- **UKSRG: United Kingdom Slip Resistance Group** – Independent authority of slip resistance.
- **Test Service** – The organisation undertaking the testing and certifying the results to the Approval Authority.
- **VUT: Vehicle Under Test** – Means a vehicle that is being tested to this protocol.

6 Test equipment and conditions

6.1 Test equipment

The measurement device used in this protocol is the PSRT as defined by the following British Standards:

- BS 7976-1:2002+A1:2013 (British Standards Institution, 2013)
- BS 7976-2:2002 (British Standards Institution, 2002)
- BS 7976-1:2003+A1:2013 (British Standards Institution, 2013)



6.2 Test conditions

All tests shall be completed in a test environment where the temperature is between 5°C to 40°C. This requirement is in addition to UKSRG guidelines (The UK Slip Resistance Group, 2016).

Tests shall only be made under wet conditions, having a thin, consistent film of water covering the entirety of the test area. This requirement supersedes Section 3.6 of the UKSRG guidelines (The UK Slip Resistance Group, 2016).

7 Test samples

Testing may be conducted at various levels of wear or aging for continued life assessment. Definition of the level of wear, stated as number of passengers, and age of the material shall be provided to the test service along with the sample/s.

Ideally the assessment of materials will be carried out on in-service vehicles however, should this not be possible, testing may be conducted upon representative material coupons within a laboratory. Testing shall be conducted following the procedure stated in section 8 for either In-vehicle or Laboratory testing.

- a) In-vehicle: Testing of the floor covering shall be performed at a number of locations. These should include, but are not limited to; the area inside the front door, the area inside any other passenger doors located down the body, the wheelchair area, the bottom of the stairs (double-deck vehicles), and any areas where passengers may stand on or travel over.
- b) Materials laboratory: Testing shall be performed using representative coupons of the floor covering material. The coupon size should be as specified by the test machine manufacturer.

8 Test procedure

The following procedure shall apply to measurements taken either using an in-service vehicle or material coupons within a laboratory.

Apply the UKSRG guidelines for measuring slip resistance using the PSRT, with the following amendments:

Tests shall be carried out within a test environment with a temperature range of 5°C to 40°C. (Addition to UKSRG guidelines (The UK Slip Resistance Group, 2016))

Tests shall only be made under wet conditions where a thin, consistent film of water covers the entirety of the test area. (Supersedes Section 3.6 of the UKSRG guidelines (The UK Slip Resistance Group, 2016))

Where possible testing of each in-vehicle location / coupon shall be conducted at three angles relative to the vehicle longitudinal axis. These are:

- 0° (Longitudinal axis)
- 90° (Lateral axis)
- 45°



Due to vehicle design and size of the test equipment there may not be room for all three angles to be tested. In which case testing should be taken as close to the test location as possible with the intention to test in 45° increments.

Photographic evidence and written description of each test location should be recorded at the time of test.

Each measurement shall be repeated until the range for five consecutive PTV measurements is less than or equal to 3.0. The mean of these 5 consecutive measurements shall be given as the Mean PTV. (This Supersedes Section 3.6, Point 9 and 10 of the UKSRG guidelines (The UK Slip Resistance Group, 2016)).

For clarity, Table 32_1 shows an example test matrix.

Table 32_1: Example test matrix for supplied specimens

Test location/coupon	Test direction (degrees)	PTV for test number:										Mean PTV
		1	2	3	4	5	6	7	8	...	n	
1	0	45	52	50	49	51	48	49				49.4
	45											
	90											

9 Assessment of results

For all test locations / coupons the 'Mean PTV' calculated for each direction shall be assessed dependent upon the samples level of usage and age.

The level of slip shall be deemed a failure if any of the 'Mean PTV' values are found to be less than those stated in Table 32_2.

Table 32_2: Minimum 'Mean PTV' requirements

Usage	Age	PTV
New	New	36.0
Greater than 100,000 Passengers	Greater than 6 months	40.0

10 Test report

The Test Service shall provide a comprehensive test report which contains UKAS test certificates for testing performed. The following should also be provided as appropriate:

- a) Material definition, including trade name
- b) The vehicle details on which the assessed material was installed Test conditions
- c) Coupon batch of manufacture for material



- d) An approximation of the number of passengers transported by the vehicle at assessment stage
- e) The amount of time that the flooring material type was in service for at assessment stage
- f) Mean PTV values
- g) Pass/Fail assessment



Attachment 33: Slip Prevention

Guidance Notes

1 Introduction

To reduce the risk to occupants of slips or falls whilst travelling the floor of all buses in service in London will be expected to be covered with materials which provide an effective level of resistance to slip.

This document sets out the guidance notes related to flooring materials. These guidance notes are aimed at bus operators and OEMs as a practical guide for implementation of the Bus Safety Standard.

These notes are for guidance only and are not legally binding. In all circumstances, the guidance provided by an OEM or system supplier shall take precedence, and these guidance notes are only for use in the absence of other information. These are not intended to be exhaustive, but to point the operators toward practical advice and questions to raise with OEMs/suppliers.

2 Selection of buses/systems

Any bus that meets the TfL Bus Vehicle Specification.

Slip resistance testing should be carried out on all bus flooring materials in an as-new condition and various usage/age conditions. The Slip Prevention Assessment Protocol: Attachment 32, should be followed for the characterisation and acceptance of materials.

3 Training

Slip resistance testing should be carried out by a United Kingdom Accreditation Service (UKAS) accredited operator. Training may be provided by UKAS or another suitable training body if required.

Training for flooring installation should be provided by the flooring supplier.

4 Certification of flooring materials

Flooring material types¹ fitted to buses shall be supplied with a certification documentation pack that the slip resistance performance required by the 'London Bus Technical Specification' is met. The performance required is:

- At installation i.e. "as new", the material will be deemed a failure if the mean Pendulum Test Value (PTV) is found to be less than 36.0.

¹ For the purposes of this document a flooring material type is considered as materials that share the same trade name and are constructed from using the same component parts and manufacturing processes.



- After 100,000 persons have accessed the material, or after 6 months in service, whichever is sooner, the material will be deemed a failure if the mean PTV is found to be less than 36.0
- Flooring material shall be assessed annually for a period of 7 years from the point of entering service. Throughout this period the material shall provide a minimum slip resistance. The material will be deemed a failure if the mean Pendulum Test Value (PTV) is found to be less than 40.0.

Assessment of the skid resistance of the materials must be carried out in accordance with the assessment protocol defined in Attachment 32. The assessment of materials must be carried by persons accredited by UKAS for the operation of the Portable Skid Resistance Tester (PSRT). This includes individuals working for the material manufacturer, OEM, bus operator or third-party test service.

The certification of materials should, where appropriate take into account possible variations in material performance between manufactured batches. This may require the assessment of material samples installed in a number of different vehicles.

For a material to be certified for use, documentary evidence of the performance of flooring material types should be submitted in the form of UKAS certificates which present as a minimum:

- The material type being assessed
- The vehicle details on which the assessed material was installed
- The Mean PTV of the material in each test direction
- An approximation of the number of passengers transported by the vehicle at the assessment stage
- The amount of time that the flooring material type was in service for at the assessment stage

This certification documentation pack should be based on one of the following options depending on whether the material is an existing or new material:

- Performance measured on in-service buses, for 'existing' materials
- Performance measured on in-service buses, for 'new' materials
- Performance measured in the laboratory, for 'existing' materials
- Performance measured in the laboratory, for 'new' materials

Each of these options is described in more detail below.

Ideally the assessment of materials will be carried out on in-service vehicles. However, to encourage innovation, laboratory tests may be deemed acceptable.

4.1 Performance measured on buses

Materials may be certified by assessing their performance on current, in-service buses.

Materials shall be assessed at each of the requisite age/usage intervals as stated in section 4. Evidence for each of the assessment increments may be gathered quickly by using materials at various ages across multiple, in-service, vehicles.

New materials may be certified by assessing the performance of those materials on in-service buses. New flooring shall have been installed by appropriately trained individuals, as per section 3. Materials shall be assessed and reported at each of the



requisite age/usage intervals stated in section 4. Should the material fail to achieve the criteria required at any stage then it must be replaced.

For certification to be achieved the performance of the materials should be assessed following the procedure defined in Attached 32 and meet the requirements specified in the London Bus Service Limited New Bus Specification Section 4.5.6.

4.2 Performance measured in the laboratory

Materials may be certificated by measuring the performance of representative samples within a laboratory.

Materials shall be assessed at each of the requisite age/usage stated in section 4.

Accelerated wear for a material coupon may be used to simulate the footfall experienced by the flooring materials at the required intervals. Additional evidence showing a strong correlation must be presented between the mean PTV for a coupon with accelerated wear against the equivalent in-service wear.

For certification to be achieved the performance of the materials should be assessed following the procedure defined in Attached 32 and meet the requirements specified in the London Bus Service Limited New Bus Specification Section 4.5.6.

5 Replacement or repair of flooring materials

5.1 Inspection

The bus flooring material shall be inspected using the standard intervals and protocols specific to the bus operating company. It is recommended however that inspections are carried out every 5 - 7 years'. The flooring material shall be visually inspected for any obvious defects following the standard inspection regimes used by the bus operating company and areas containing defects (as defined by the operating companies inspection regime) noted.

5.2 Replacement

If defects are identified the affected section of the surface should be completely replaced with one characterised as providing a low slip potential. A section of the surface is defined as an area of the surface which can be independently defined by its use. For example, a bus may consist of the following surfacing sections:

- Entrance ways
- Aisles
- Stairwells and landings
- Disabled reservation areas
- Etc.

If therefore a defect was identified in the aisle of a bus, then the entire width of flooring between the seats should be replaced.

Persons replacing bus flooring materials should be trained and competent to do so. The OEM's installation instructions should be followed precisely when replacing materials and, if available, training by the material supplier should be given.



Particular care should be taken when welding material joints in order to protect the underlying materials.

5.3 Inspection and repair of the underlying materials

After the removal of defective material (and the surrounding area), the underlying materials should be inspected for damage and repaired as necessary. Conducting repairs at this stage will lengthen the life of the flooring materials and the bus.

6 Cleaning of bus flooring materials

The selection of bus flooring materials should take into account their cleaning and maintenance procedures. It is advised that materials with high levels of texture, or materials that are very coarse are not used. These materials are likely to provide high levels of PTV but will also be very hard to clean and could trap dirt and contaminants that could ultimately reduce their PTV characteristics.

Bus flooring materials should be cleaned regularly following the OEMs recommended procedures. In cases where there are no OEM recommended procedures the following should be carried out:

1. Daily:
 - a. Vacuum the surface to remove dust and debris,
 - b. Use a mop to clean floor with clean water and a 2-5% neutral detergent solute as per product's instructions,
 - c. Rinse surface with a thoroughly cleaned mop and clean water to remove detergent residue.
 - d. Vacuum dry.
2. Once per month or after heavy soilage:
 - a. Vacuum the surface to remove dust and debris,
 - b. Scrub grease or oil spots only with a medium stiff bristled hand brush, rotocleaner or dingle brush machine with alkaline detergent
 - c. Use a mop to clean floor with clean water and a 2-5% neutral detergent solute as per product's instructions,
 - d. Rinse surface with copious amounts of clean water using a thoroughly cleaned mop to remove detergent residue.
 - e. Vacuum dry.
3. Never:
 - a. Use an electric scrubber with abrasive discs,
 - b. Use solvents,
 - c. Use industrial stain removers without first testing on a discrete area out of natural corridors,
 - d. Leave detergent residue on the floor,
 - e. Apply any surface treatment,
 - f. Use high pressure devices,
 - g. Place any form of rubber on the flooring.



7 Considerations of flooring colouring and patterns

It should be noted that the use of darker colours for bus floorings is preferential to lighter colours as dirt and detritus is less contrasting with darker colours and so is less visible.

There is a potential that flooring which is reflective or has reflective elements can look “sparkly” or “shiny”. There is the potential for some bus passengers to sub-consciously associate these features with flooring that is wet and therefore slippery. In these cases it is likely that these users will adjust their gait to compensate for the perceived lack of slip resistance. This is undesirable as it increases the risk to the passenger who may become off balanced or even fall as a result. With this in mind, the use of materials with a matt hue are preferred to those with satin or gloss hues.



Attachment 34: Occupant Friendly Interiors Assessment Protocol

1 Introduction

This document presents a protocol for inspection of a bus interior to identify potential injury hazards and the assessment and rating of hazards identified.

The categories of potential hazards include Handrails, Restraints, Partitions, inadequately constrained seated passengers, and General/other hazards such as sharp corners and protrusions.

For full understanding of this Attachment, it should be read in conjunction with the Attachment 35: Occupant Friendly Interiors Guidance Notes and New Bus Specification, Section 4.5.2, Section 4.5.3, Section 4.5.4 and Section 4.5.5.

2 Scope

This protocol applies to all new buses intended for service under contract to TfL that are passenger vehicles with a maximum mass exceeding 5 tonnes and a capacity exceeding 22 passengers. The passenger vehicles will be capable of carrying seated but unrestrained occupants and standing occupants. Such vehicles are categorised in the Consolidated Resolution on the Construction of Vehicles (R.E.3) as M₃; Class I.

3 Purpose

The purpose of this assessment is to identify potential injury hazards present in the vehicle design. The protocol assesses and rates the identified hazards with the objective of encouraging safer vehicle designs, with minimal constraints for the vehicle designers. The protocol has been written to enable assessment using drawings or CAD models of the vehicle at the design stage.

4 Normative references

The following normative documents, in whole or in part, are referenced in this document and are indispensable for its correct application. For dated references, only the edition cited applies. For undated references, the latest edition of the referenced document (including any amendments) applies.

- London Bus Services Limited New Bus Specification: Section 4.5.4
- London Bus Services Limited New Bus Specification: Section 4.5.5
- London Bus Services Limited New Bus Specification: Attachment 35 Occupant Friendly Interiors Guidance Notes

5 Definitions

For the purpose of this Protocol:

- **3D:** Three dimensional, components in the x, y and z axes.
- **Approval Authority:** The Approval Authority is the body within TfL that certifies that a bus is approved for use in the TfL fleet and assigns its score under the bus safety standard for use in procurement processes.
- **Computer-Aided Design (CAD):** The use of computer systems to aid in the creation, modification, analysis, or optimization of a design.
- **Floor:** Vehicle floor where a passenger's feet will rest when seated or standing.
- **'High occupancy / PRM' seats:** Seats with high occupancy rate and / or used by Persons with Reduced Mobility (PRM)—These seats include nominated priority / preferential seats, all seats on the main floor level and any seats immediately adjacent to a door. "Immediately adjacent to a door" means any seat in a row of seats near a door, even if only accessible via a step. Example of these seats behind the middle doors and wheelchair area with step to access are shown in Figure 34_1.



Figure 34_1: Examples of seats with high occupancy rate immediately adjacent to a door and only accessible via a step.

- **OEM: Original Equipment Manufacturer** – The company responsible for the manufacture of a completed bus, delivered to a bus operator
- **Passenger trajectory plane (PTP):** Vertical planes which describe the likely directions of travel for a passenger who is thrown forward in the vehicle.
- **Position line (PL):** Lines which represent a position from which a passenger could be thrown forward in the vehicle
- **Primary handrail:** The handrail being assessed
- **Secondary handrail:** A handrail that can be used by a passenger to prevent a collision with the primary handrail. **Note that hanging grab holds/straps shall not be defined as secondary handrails**



- **Test Service:** The organisation undertaking the testing and certifying the results to the Approval Authority
- **Vehicle under Test (VUT):** Means the vehicle assessed according to this protocol.

6 Test conditions

This protocol has been developed to be applied during the design of buses. This protocol shall be applied to CAD models or drawings of the VUT.

7 Test preparation

The following assessment envelopes/zones shall be defined by the Test Service in a universally compatible 3D CAD format e.g. *.IGES or *.STEP.

7.1 Standing passenger vertical handrail assessment space envelope.

A plan view of the envelope is shown in Figure 34_2.

Each of the boxes shall be 500mm x 500mm area

The envelope shall extend from the ground plane of the VUT to a height of 1870mm. The ground plane of the space envelope shall follow the profile of the vehicle floor, this should include any steps that are present. It is possible that the additional height of the steps may make it difficult for a passenger to stand in the associated box areas. In this case, these boxes would be excluded from further assessment, because only areas where passengers are likely to stand are assessed.

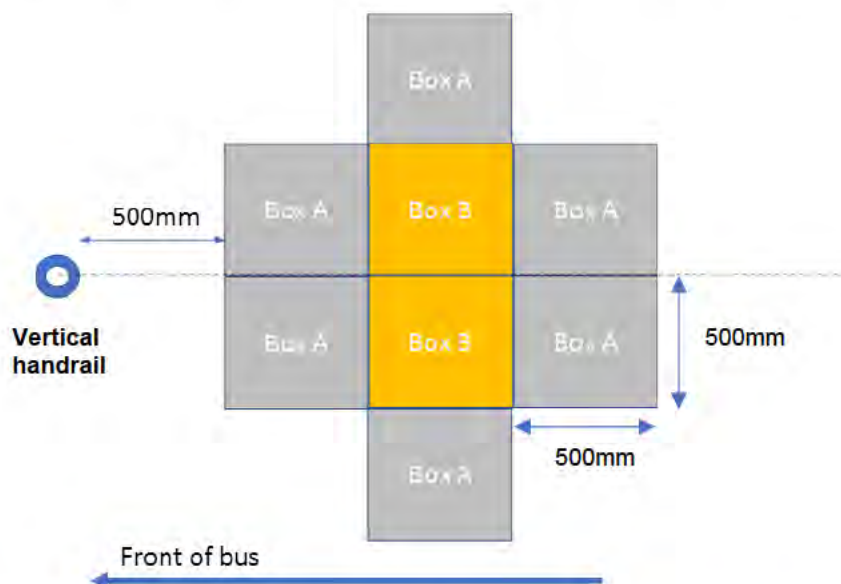

Figure 34_2: Plan view of the vertical handrail assessment space envelope.

7.2 Standing Passenger Head Impact Assessment Zones

The following two head impact zones are defined for standing passengers:

1. Zone for assessment of vertical and horizontal handrails (see Section 8.1.1.1, Section 8.1.1.2, Section 9.1.1.1 and Section 9.1.1.2):

The height of this zone is from 1160 mm to 1870 mm above the floor level of the VUT with a critical zone defined from 1340 mm to 1755 mm (Figure 34_3).

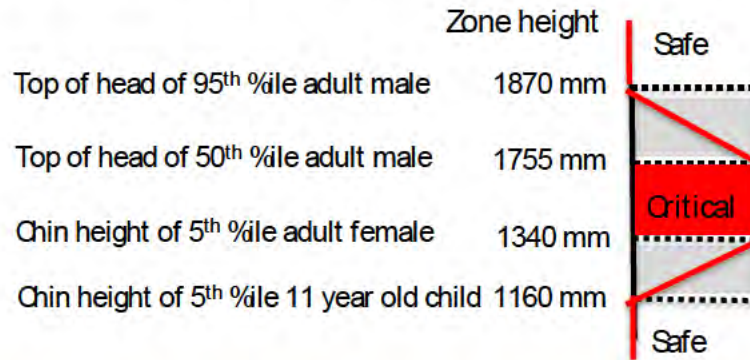

Figure 34_3: Zone for assessment of horizontal handrails

2. Zone for assessment of general / other hazards (Section 8.1.3 Section 9.1.3):

The height of the zone is defined as from floor level of VUT to 1870 mm (top of head of standing 95th percentile adult male) above floor level.

7.3 Seated Passenger Vertical Handrail Impact Assessment Zone

A side view of this zone relative to the seat being assessed is shown in Figure 34_4. The zone shall extend for the width of the seat being assessed.

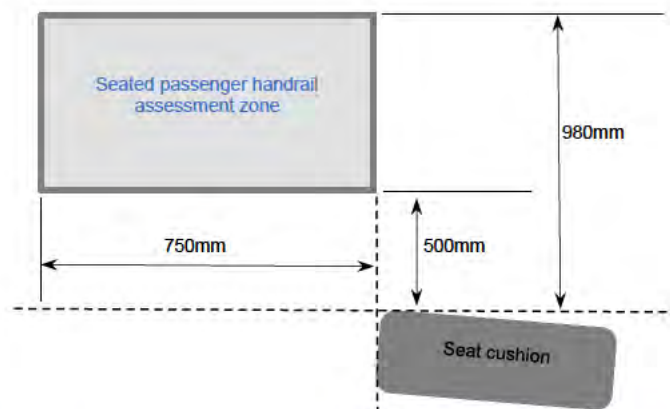

Figure 34_4: Side view of seated passenger handrail assessment zone

7.4 Seated Passenger Head and Body Impact Assessment Zones



Head (inner and outer) and body impact zones are defined for each seating position as illustrated in Figure 34_5.

Head impact zones - forward facing seat

- Height (inner and outer zones): bottom 500 mm, top 980 mm above front of seat cushion, (based on anthropomorphic data)
- Width:
 - Inner zone (high impact risk): 180 mm centred around seat centre
 - Outer zone (lower impact risk): aisle seat; seat aisle edge to seat bodyside edge, exclude inner zone; bodyside seat, aisle seat edge to bodyside window (to include window surround in zone), exclude inner zone
- Length (inner and outer zones): 1100 mm from seat back at front of seat cushion height (measured at seat centreline)

Head impact zones - rearward facing seat

- Height and width as per forward facing
- Length: 300 mm from seat back at front of seat cushion height (measured at seat centreline)

Body impact zone – (forward facing seat only)

This zone consists of a single zone across its width, i.e. it does not consist of inner and outer zones as for the head

- Height: Floor to bottom of head impact zones for forward facing seat
- Width: As for head but only extends to bus body side, i.e. excludes window surround

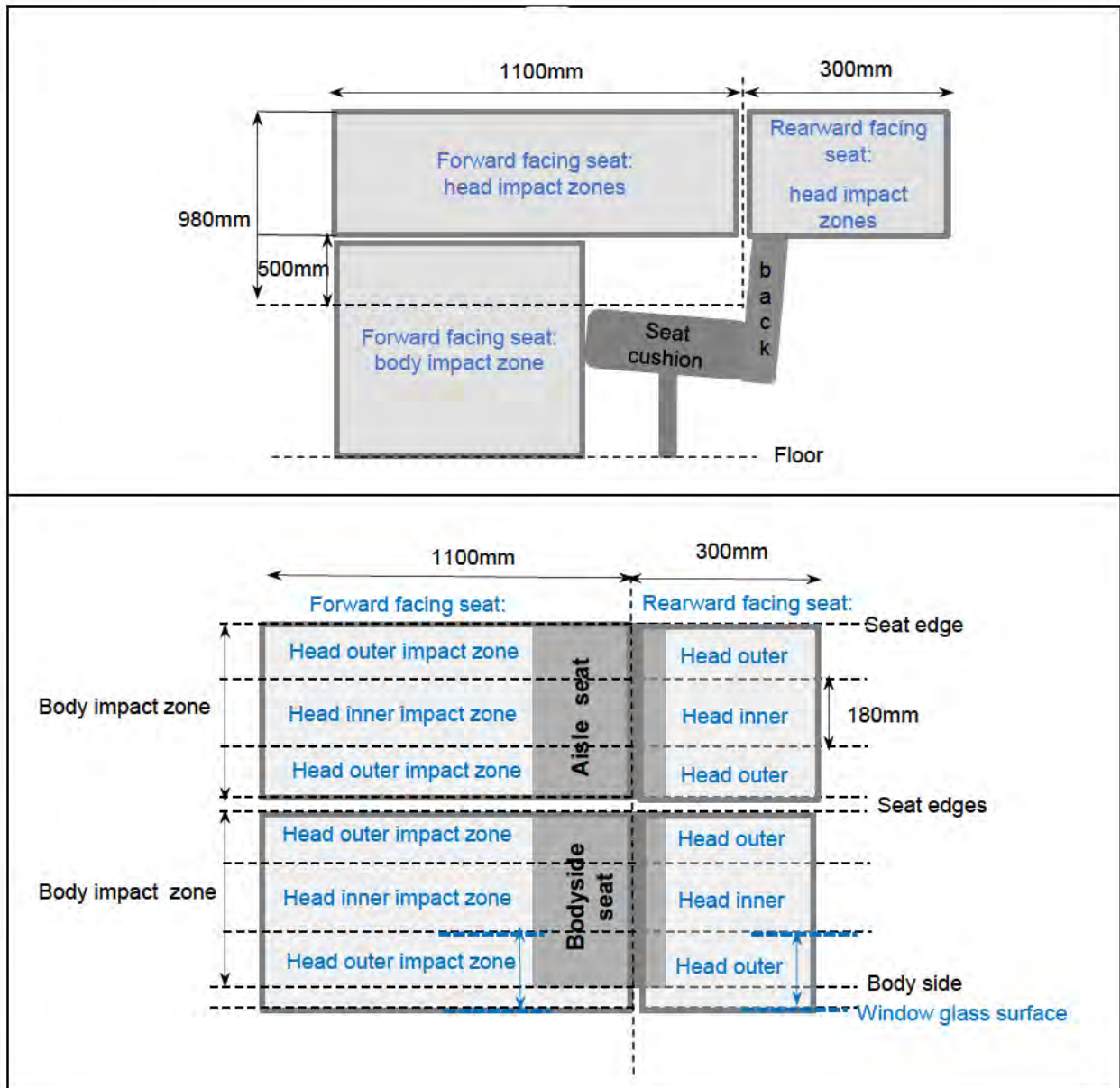

Figure 34_5: Side (top) and plan (bottom) views of seated passenger head (inner and outer) and body impact zones



8 Test Procedure

8.1 Standing Passengers

This part of the procedure only applies to the lower deck of the VUT on the basis that standing (for substantial periods) is prohibited on the upper deck.

8.1.1 Standing Passenger Handrails

Purpose:

- To encourage vertical handrails to be positioned where they are less likely to be hit by a standing passenger who falls.
- To discourage the placement of horizontal handrails at a height, level with a passenger's head, where they are likely to be impacted

The procedure considers vertical and horizontal handrails separately.

8.1.1.1 Vertical handrails

A vertical handrail is defined as a vertical structure which passes through two horizontal planes; 11310 mm and 1870 mm above the floor of the VUT at the location where the structure is installed. The diameter or width of the vertical structure in the vehicle's lateral plane shall be less than 45 mm. Attachments to the hand rails such as Oyster Card readers shall not be included in the definition of the structures diameter/width.

Note: The London Bus Services Limited New Bus Specification Section 4.5.3, 'Occupant Protection - handrail/stanchion construction and installation', amongst other things, requires:

seat back to ceiling handrails (with bell push) at all forward facing seats in the lower saloon and at alternate seats in the upper saloon

which is generally above that required by the performance based regulatory requirement.

All vertical handrails shall be identified and the following process followed.

1. Apply the Vertical Handrail Assessment Space Envelope to each of the vertical handrails identified (see section 7.1). The centre of the handrail being assessed is the reference point for the template see example in Figure 34_6.
2. Identify the boxes in which a passenger is likely to stand by applying the following criteria:
 - Identify encroaching structures for each of the boxes within the space envelope.
 - There shall be at least space to fit a circle of 250 mm diameter touching the edge of the box that does not have any permanent structure encroaching within it for the box to be assessed that a passenger is likely to stand in it.

The example shown in Figure 34_6 identifies which boxes a passenger can stand in by using 250 mm diameter circles. 4x Box 'A's and 1x Box 'B' are identified (see the green arrows).

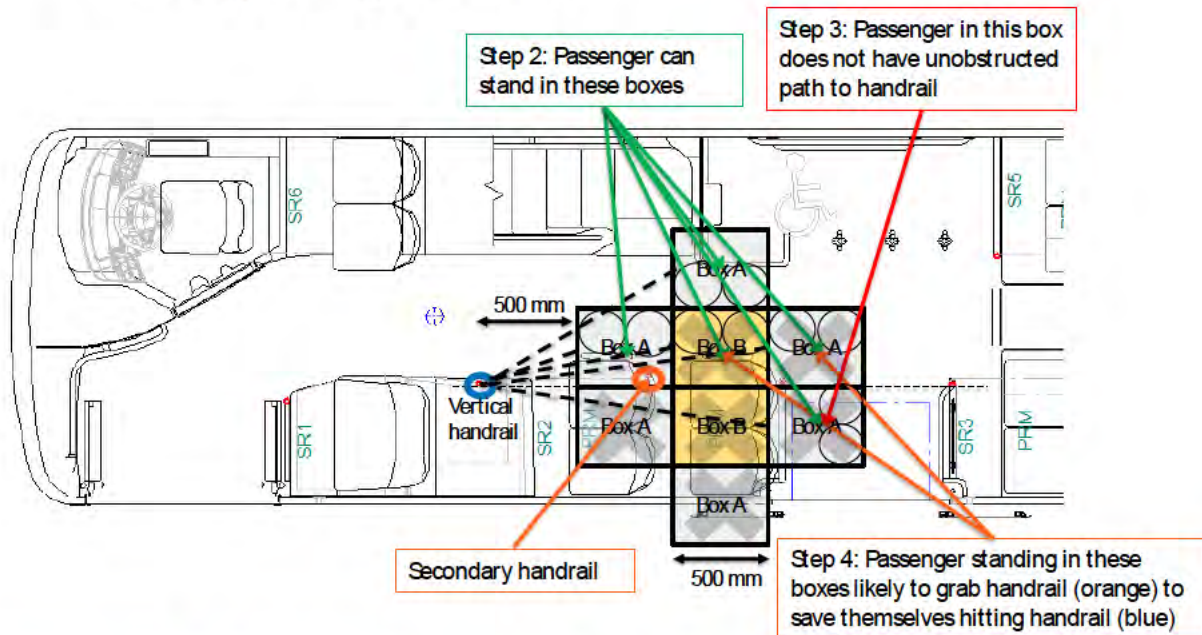

Figure 34_6: Example of assessment of vertical handrail positioned ahead of PRM seats in luggage storage area.

3. Determine if a passenger has an unobstructed path from a box to fall against the primary handrail. There shall be an unobstructed corridor at least 250 mm wide from the box to the primary handrail, defined using the following method:
 - a) Along the forward edge of the box, draw three position lines (PL) each 250 mm long, one from each of two box corners to the edge's centre point, and one with the edge's centre point at its mid-point (see Figure top picture lines in black, blue and red).
 - b) For each PL, draw potential trajectory corridors by extending a vertical plane from each end of the position line to the edge of the handrail (so that the edge of the handrail is just touching the boundary of each corridor). The plane extending from the end of the PL farthest away from the primary handrail shall contact the handrail at the farthest point and the plane extending from the end of the PL nearest the handrail shall contact the handrail at its nearest point. Add two other planes parallel to each of these lines as illustrated in Figure bottom picture. When complete this will give 6 corridors; two corridors for each PL.

If one or more of these corridors does not have a structure encroaching into it (at a height less than 1870 mm above bus floor level), it is deemed that a passenger has an unobstructed path to the primary handrail. Note that structures less than 300 mm from the primary handrail which do not shield it completely in the head impact zone (1340 mm to 1755 mm above bus floor) should not be counted as obstructions.

The example shown in Figure 34_6 6 shows that a passenger standing behind the seats in front of the middle doors does not have an unobstructed path to the handrail highlighted in blue (see red arrow). This reduces the number of relevant boxes to 3x Box 'A's and 1x Box 'B'.

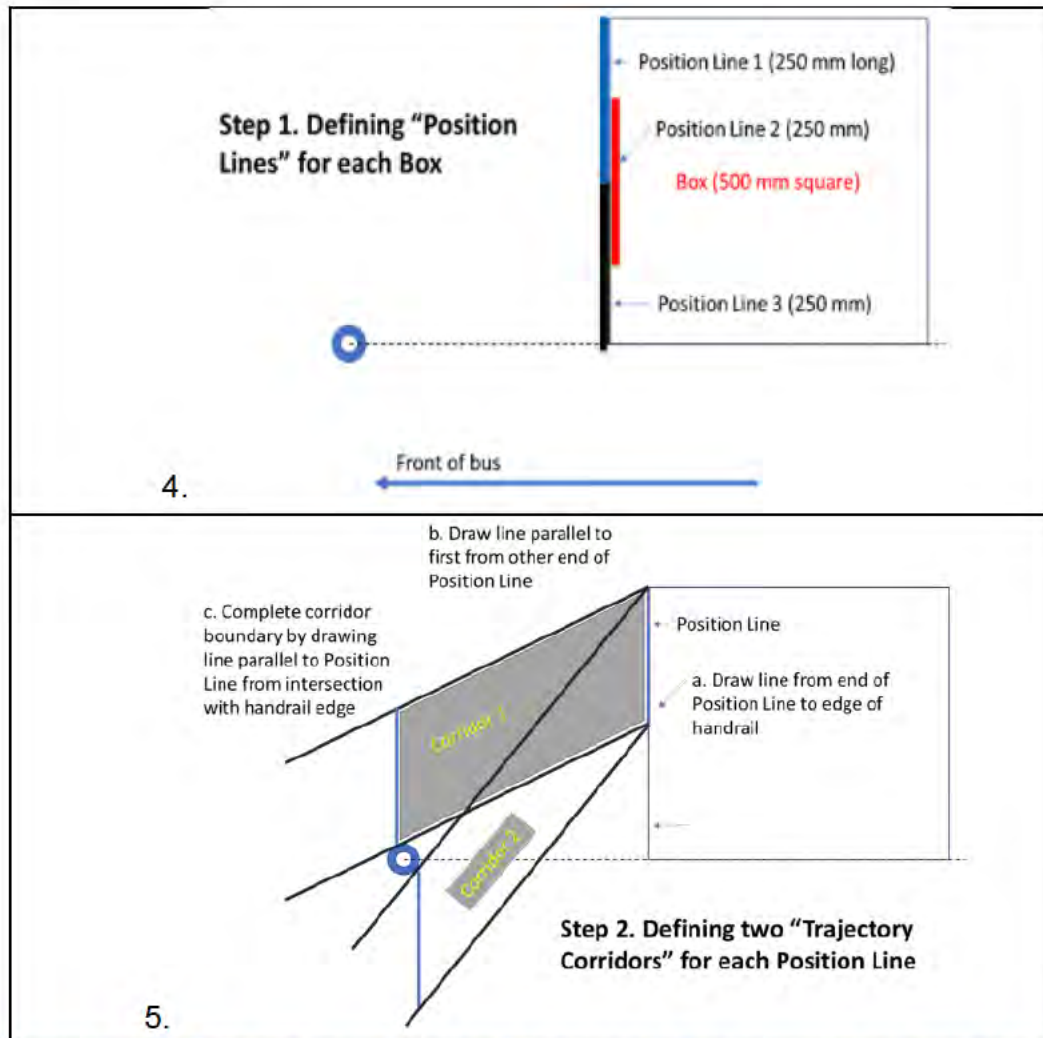

Figure 34_7: Procedure to assess presence of unobstructed corridor to vertical handrail.

4. Determine whether passengers have an opportunity to grab another handrail (secondary handrail) to prevent a collision with the primary handrail using the following method:
 - a) The Passenger Trajectory Plane (PTP) (shall be drawn from the centre of the front of each box to the centre of the primary handrail.
 - b) A secondary handrail is defined as one positioned at least 500 mm longitudinally from the primary handrail and within a corridor extending 250 mm either side of the PTP. In the case of curved handrails, the above measurements shall be taken at a height of 1384mm from the floor height.

Note: Hanging grab holds/straps shall not be defined as secondary handrails



For the example in Figure 34_6, the secondary (seatback to ceiling) handrail highlighted in orange will offer passengers standing in the Box B and Box A behind it indicated (see orange arrows), an opportunity to grab it and save themselves from hitting the vertical handrail being assessed. This reduces the number of relevant boxes (in which a passenger could stand and likely fall and hit the handrail being assessed) to 2x Box 'A's (ones without grey crosses in them).

8.1.1.2 Horizontal handrails

1. All horizontal handrails shall be identified.
2. The height of the middle of each handrail above the bus floor shall be measured.
3. The length of each handrail shall also be measured.

8.1.2 Standing Passenger Restraints

Purpose:

To encourage partitions that a passenger may stand behind to be of sufficient height to restrain the motion of a passenger in the event of emergency braking and / or a collision, i.e. they are not thrown over it.

A partition-like structure (for standing passengers) is defined as structure (e.g. seat(s) and/or handrail(s)) which has sufficient strength and interaction area to restrain the movement of a standing passenger's body parts through it during a collision or braking type event.

1. Partitions that a passenger can stand behind shall be identified.

This shall be achieved by measuring the space available for standing passengers behind all partitions. If this space extends at least 500 mm rearward across the width of the partition, has a width > 250 mm and is open to a height of 1870 mm, the partition shall be identified as one which can be stood behind.
2. The width of the partitions identified (as one which can be stood behind) shall be measured.

If the partition width varies with height, it shall be measured at a height of 1060 mm or at the top of the partition if its height is lower
3. The average height of the partition above the VUT floor shall be measured. Guidance of how to do this for partitions which consist of multiple structures with a longitudinal offset and/or uneven top profiles, such as those shown in Figures 34_8 and 34_9, are given below.
 - Multiple structures (see Figure 34_8):
 - If the top of the forward most structure is less than 170 mm longitudinally of the rearward most structure (measured from rear of



rearward most structure to rear of forward most structure), the height of the partition shall be defined as the height of the higher structure.

- If the top of the forward most structure is more than 170 mm longitudinally of the rearward most structure (measured from rear of rearward most structure to rear of forward most structure), the height of the partition shall be defined as the height of the rearward most structure.
 - Exception: if the height of the forward most structure is more than 500 mm higher than the rearward most structure, the height of the partition shall be defined as the height of the forward most structure
- Uneven top profiles (see Figure 34_9):
 - Measure profile of top of partition taking height measurements, if necessary, up to every 50 mm along its width
 - For multiple structures, follow guidance above to measure max height of appropriate structure
 - Bridge any gaps in profile less than 100 mm wide and integrate to determine average height of partition

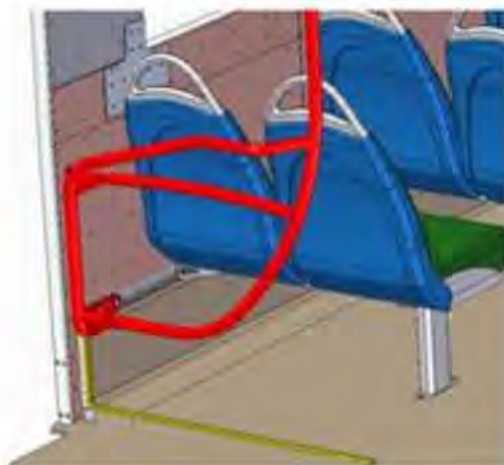

Figure 34_8: Example of partitions consisting of multiple structures

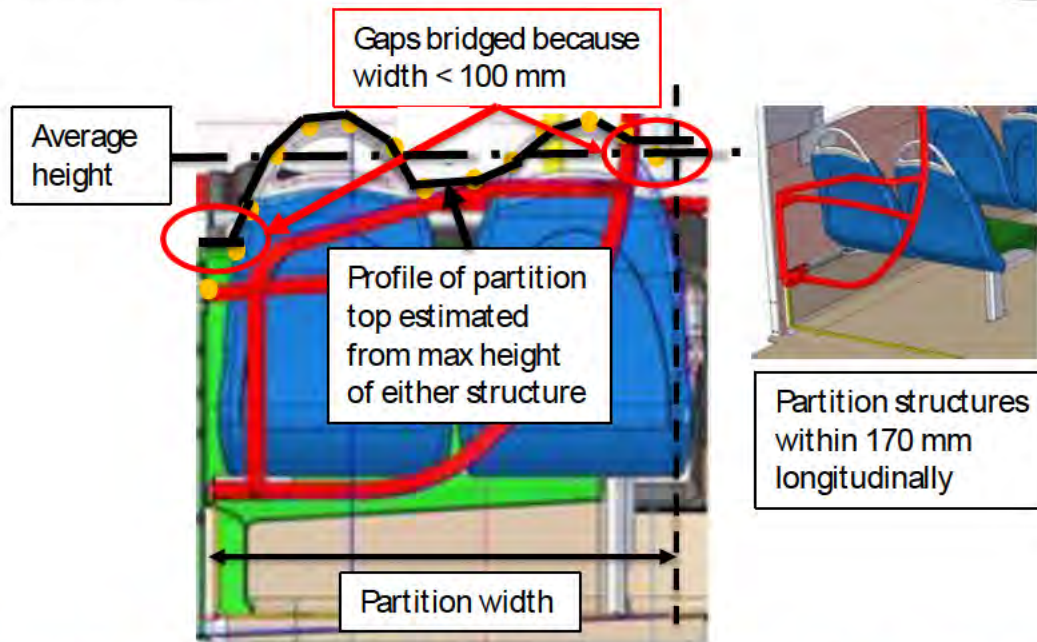

Figure 34_9: Measurement of width and average height for partition with multiple structures and uneven height

8.1.3 Standing Passenger General/other Hazards

Purpose:

To encourage the removal of features, such as sharp edges / corners and protrusions, that a standing passenger may hit when they fall, with focus on head impact.

1. Hazards meeting the following criteria shall be identified:

- Edge or corner with predominant radius < 20 mm and protrusions with height from surrounding surface > 3.2 mm which are:
 - Located within the head impact zone (see Section 7.2, point 2)
 - Situated in a position such that bus interior furniture (seats) do not prevent it from being impacted by the head of a standing passenger (a standing passenger is not likely to be thrown sideways over a pair of seats to impact an object mounted on the bus's bodyside). Guideline for assessment is to include objects positioned < 0.5 m over interior furniture (seats) from where passengers permitted to stand and include objects within space where standing passengers could be thrown in the event of harsh braking or a collision (e.g. non-standing area in front of driver cab).
 - Can be contacted by 165 mm diameter sphere, i.e. is not shielded by another feature such as a handrail, partition or seat which prevents head contact



- Made from material with a Shore A hardness¹ greater than 50
- Attached to bus rigidly, i.e. displaces < 5 mm with application of 20N load
- Note: components which have been designed to move (e.g. armrests) should be assessed in all normal in-use positions and worst case taken

2. Exclude the following from hazards identified:

- Handrails*because these are assessed separately*
- Brackets / clamps which hold partition structures with no or small protrusions < 3.2 mm and blunted / radiused edges, ideally radii > 2.5 mm
- Armrests with predominant radii > 5 mm
- Step edges ...*because these are required to prevent passenger slips/trips/falls*
- Stop buttons with standard rounded design OR exposed radii > 2.5 mm
- Window surrounds with predominant radii > 5 mm
- Handholds (on high backed seats) with predominant radii > 10 mm
- Protrusions with height > 3.2 mm which meet UNECE Regulation No. 21 para 5.1.4 and/or 5.1.5 as appropriate – **The OEM is to provide documentary evidence**
 - Paragraph 5.1.4.:Features made of rigid material, which project 3.2 mm to 9.5 mm from the surrounding structure, shall have a cross-sectional area of not less than 2 cm², measured 2.5 mm from the point projecting furthest, and shall have rounded edges with a radius of curvature of not less than 2.5 mm
 - Paragraph 5.1.5Features made of rigid material, which project more than 9.5 mm from the surrounding structure, shall be so designed and constructed as to be able, under the effect of a longitudinal horizontal force of 378 N delivered by a flat-ended ram of not more than 50 mm in diameter, either to retract into the surface of the structure until they do not project by more than 9.5 mm or to become detached; in the later case, no dangerous projections of more than 9.5 mm shall remain; a cross section not more than 6.5 mm from the point of maximum projection shall be not less than 6.5 cm² in area.
 - Note: for further detail see UNECE Regulation No 21²

3. Identify groups of hazards which can be contained in a rectangular area 10 cm x 10 cm.

4. Count number of hazards identified; note that a group of hazards as defined in point 3 above shall be counted as one hazard only.



¹ Shore hardness is defined as a material's resistance to indentation when a static load is applied.





² UNECE Regulation No 21: <https://op.europa.eu/en/publication-detail/-/publication/588aa860-5042-4063-ad75-8ae5e18af385/language-en>









- Determine and record edge orientation (transverse or longitudinal) and protrusion height as appropriate for each hazard and hazard group (see Section 9.1.3 and Figure 34_20).

Examples of items which should be included and excluded as hazards are shown across the following pages in (Figure 34_10).

<u>Include as general hazard</u>	<u>Exclude as general hazard</u>
 <p data-bbox="272 1099 762 1167">Seat mount structure sharp corner (radius < 20 mm).</p>	 <p data-bbox="871 1189 1369 1368">Step edges with small radius in direction perpendicular to travel (because these are needed to prevent slips/trips/falls on step and ensure functionality).</p>

<u>Include as general hazard</u>	<u>Exclude as general hazard</u>
 <p data-bbox="284 826 831 931">Mirror (provided in head impact zone - < 1870 mm above floor - and rigidly attached.</p>	 <p data-bbox="871 667 1334 703">Stop button with rounded design</p>
 <p data-bbox="368 1420 743 1456">Heating unit corner / edge</p>	 <p data-bbox="871 1330 1374 1442">Brackets / clamps holding partition-like structures – radii blunted, no protrusion > 3.2 mm</p> <p data-bbox="871 1458 1390 1570">Note: edges of glass partition also shielded from impact by partition rail structure</p>

<u>Include as general hazard</u>	<u>Exclude as general hazard</u>
 <p data-bbox="295 898 821 965">Passenger Information System (PIS) corner</p>	 <p data-bbox="869 1055 1380 1160">Grab handles on straps attached to structures above 1870mm from the VUT floor</p>

<u>Include as general hazard</u>	<u>Exclude as general hazard</u>
 <p data-bbox="293 1122 820 1267">Protruding driver compartment door hinges with sharp edges (note 2 hazards because more than 100 mm apart)</p>	 <p data-bbox="868 808 1382 880">Window surround with predominant radii > 5 mm</p>
 <p data-bbox="277 1883 836 1917">Armrest with predominant radii < 5 mm</p>	 <p data-bbox="868 1637 1350 1709">Handhold (on high backed seats) with predominant radii > 10 mm</p>

<u>Include as general hazard</u>	<u>Exclude as general hazard</u>
	 <p data-bbox="871 891 1369 996">Armrest with predominant radii > 5 mm – note armrest shown fitted to train</p>

Figure 34_10: Examples of features which should be identified as general hazards for standing passengers, and those which should be excluded

8.2 Seated Passengers

The assessment shall be completed for both the lower and upper decks for forward facing seats.

8.2.1 Seated Passenger Handrails

Purpose:

To encourage vertical handrails (mainly seat back to ceiling) to be positioned more inboard to reduce the risk of head impact for seated passengers.

1. Identify vertically orientated handrails positioned within the seated passenger head impact assessment zone. Examples of handrails in this zone are shown in Figure 34_11. Handrails can be straight or curved.

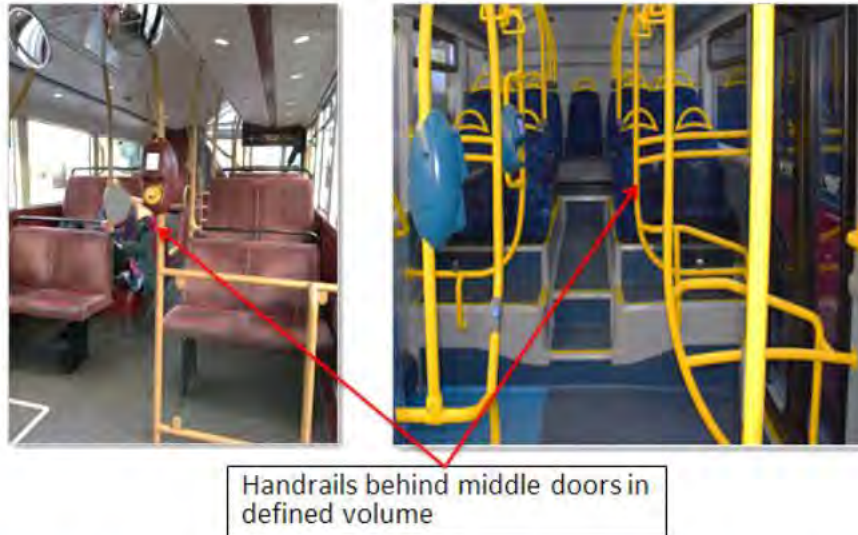

Figure 34_11: Examples of handrails positioned behind middle doors in trajectory of seated occupant that shall be identified for further assessment.

2. For each of the handrails identified, take the following measurements relative to the longitudinal centreline of the seat:
 - D_{LatHR} - Lateral (y-axis) distance from boundary (edge) of the handrail nearest to the seat centreline to the outer edge of the seat.
 - W_{seat} - The maximum width of the seat.
3. For curved handrails measure D_{LatHR} at 5 heights relative to head impact zone as follows: bottom, 25%, middle, 75%, top, as per Figure 34_12

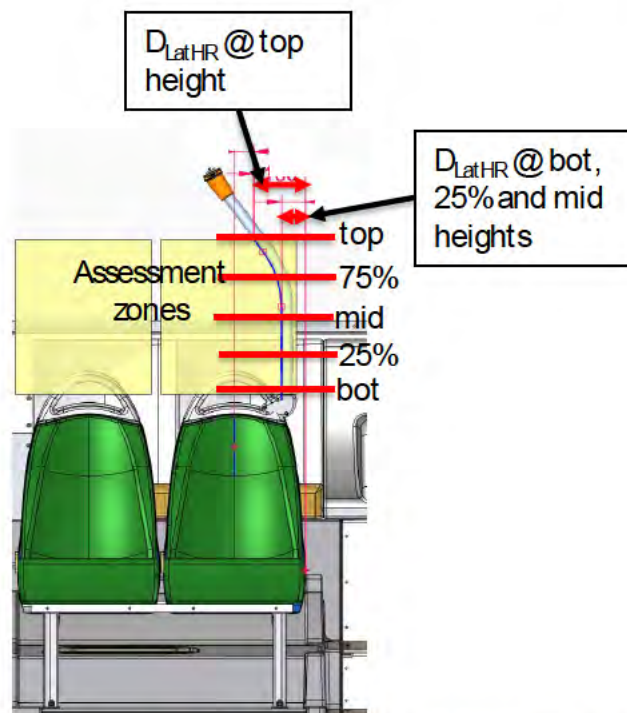

Figure 34_12: Measurement of D_{LatHR} for curved handrail at 5 heights, bot, 25%, mid, 75%, top



Note: Child/parent seats, which are wider than standard seats, should be assessed as standard adult seats. Reasons for this include:

- Child/parent seat is often occupied by one adult only.
- Assessment for adult will drive changes that are beneficial for when seat occupied by parent and child, i.e. encourage position of vertical (seatback to ceiling) handrails to be more inboard to reduce risk of head impact

4. Identify whether the handrails assessed are associated with ‘high occupancy / PRM’ seats.

Example shows assessment of vertical handrail positioned in front of seats behind luggage rack (Figure 34_13).



Figure 34_13: Assessment of vertical handrail positioned in front of seats behind luggage rack showing handrail > 750 mm longitudinally from front of seat cushion and therefore outside ‘vertical handrail impact assessment zone’

Assessment shows vertical handrail positioned outside vertical handrail impact zone (see Section 7.1), therefore, vertical handrail does not score (i.e. scores zero).

Note: Luggage retention rail height below height of head impact zone so not assessed as potential head impact hazard (see Section 8.2.3).

8.2.2 Restraint

Note: The London Bus Services Limited New Bus Specification Section 4.5.4

Purpose:

To encourage structures in front of seated passengers (partitions or seatbacks) to have sufficient height and width to constrain passenger motion during harsh braking or a collision type event, i.e. they are not thrown over or around side of structure.



'Occupant Protection - guards for exposed seats', requires that:

as specified in the 06 series of amendments for UNECE Regulation No. 107, guards for exposed seats shall be fitted as per the performance requirements where any seated passenger is likely to be thrown forward into a designated wheelchair space, buggy (pram) space, or open area for standing passengers as a result of heavy braking.

A partition-like structure (for seated passengers) is defined as a semi-continuous structure with apertures no greater than 100 mm and a lower edge not more than 100 mm above the floor where the passenger's feet rest for at least 66% of its length.

1. For each seat, identify the level of restraint present using the following categories:
 - a) No partition-like structure or other seats in front
 - b) Bay seat arrangement – defined as two sets of two seats facing each other
 - c) Some structure within a longitudinal distance of 1200 mm from seat back
2. Where a seat has some structure in front of it, take the following measurements as illustrated in Figure 34_14:
 - H_{feet} : The average height above the floor on which the passenger's feet rest for the seating position being assessed. Make measurement of average height for structure present in alignment with central 50% of seat width only.

Notes:

 - If structure not present over 50% of seat width, make average measurement for structure present only – structure will be penalised separately on basis of its lack of lateral coverage, i.e. D_{LatRes} .
 - For structure with uneven top profile, measure average as described in Section 8.1.2 'Standing restraint', i.e. take height measurements up to every 50 mm, if necessary bridge gaps < 100 mm and integrate to determine average.
 - D_{LatRes} : Lateral (y-axis) not covered by restraint / partition-like structure. Measure the distance from the centre of the innermost seat to the boundary (edge) of the restraint structure nearest the centre of the bus.

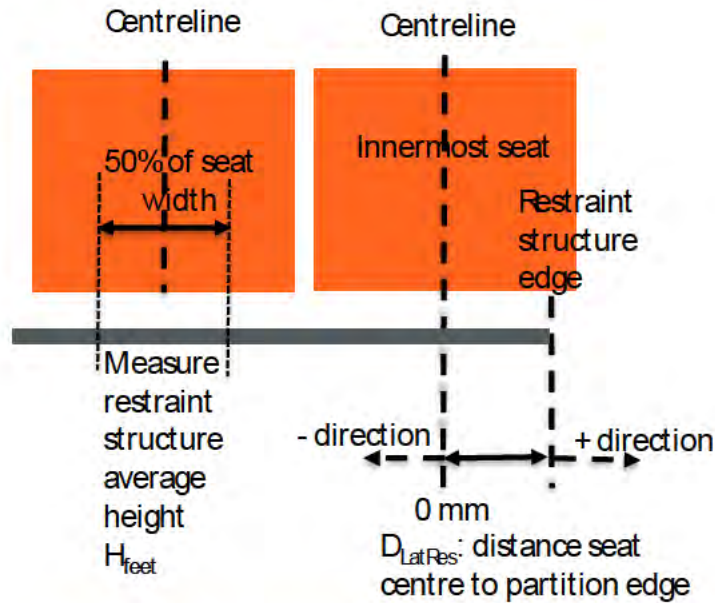

Figure 34_14: Measurement of H_{feet} and D_{LatRes}

- For restraint structures with curved edges measure width at height of 500 mm (seat cushion / knee level) and 800 mm (or top of partition if height < 800 mm) and record minimum value of D_{LatRes} measured as illustrated in Figure 34_15.

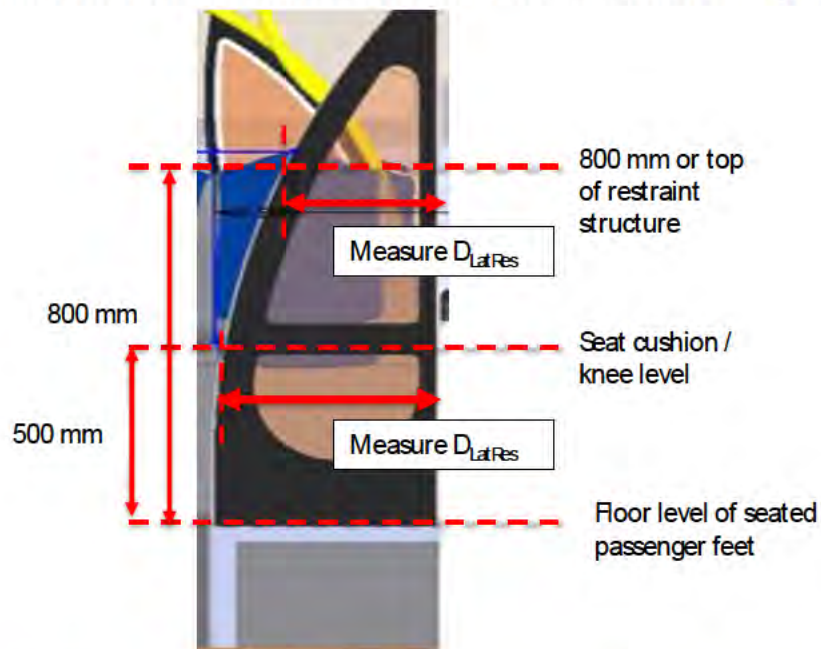

Figure 34_15: Measurement of D_{LatRes} for curved restraint structure

- Identify whether or not the restraints assessed are associated with PRM seats.

Inadequate restraint of passengers on some seats

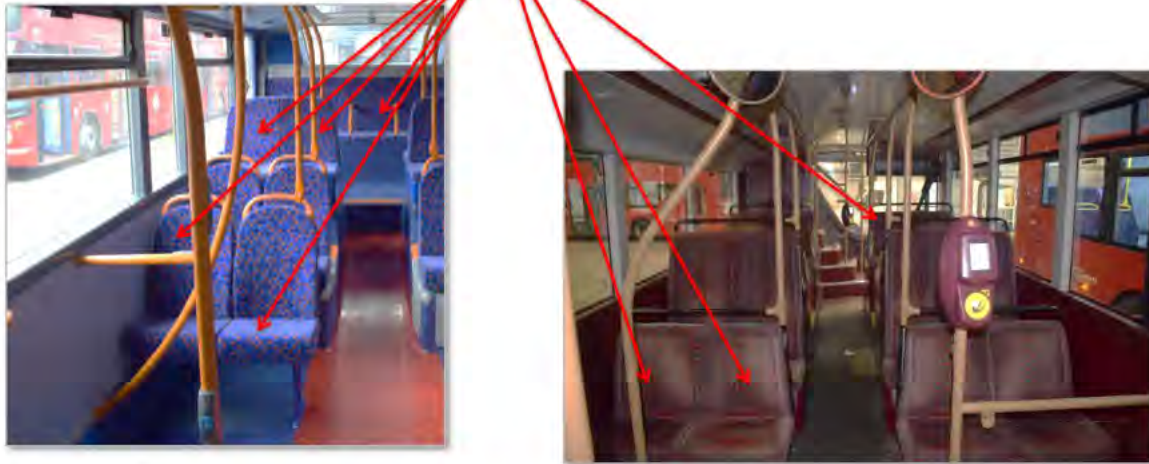

Figure 34_16: Examples of seats where there is inadequate restraint of seated passengers

Note: to help understanding of the process, an example of the assessment of the restraint provided by the wheel box / luggage area is shown in Section 9.2.2.

8.2.3 General hazards

Purpose:

To encourage the removal of features, such as sharp edges / corners and protrusions, that a seated passenger may hit mainly when they are thrown forward during harsh braking or a collision type event.

1. Hazards meeting the following criteria shall be identified:
 - a) Edge or corner with predominant radius < 20 mm or with predominant radius > 20 mm and protrusions with height from surrounding surface > 3.2 mm which are:
 - Located within the seated head (inner or outer) or body impact zone.
 - Zones defined in Section 7.4.
 - Can be contacted by 165 mm diameter sphere in head impact zone or 100 mm diameter sphere in body impact zone, i.e. is not shielded by another feature such as a handrail, partition or seat which prevents head (or body) contact
 - Made from material with a Shore A hardness³ greater than 50
 - Attached to bus rigidly, i.e. displaces < 5 mm with application of 20N load

³ Shore hardness is defined as a material's resistance to indentation when a static load is applied.



Note: Hazard identification shall be performed for all frequently used conditions, e.g. for USB port assess with lead plugged in and not plugged in.

2. Exclude the following from hazards identified:

- In head impact zones:
 - Structures with large radii (> 200 mm) and area (> 400 cm²), i.e. large flat type structures which include:
 - Full height glass panels for weather protection,
 - Partitions located behind driver cab,
 - Windscreen in front of upper deck front seats provided guard as required by UN Regulation 107 fitted
 - Handrails / handholds on the top of low backed seats provided their maximum height is < 1040mm above level of floor where passenger seated behind places their feet and they have predominant radius > 10 mm
 - Vertical handrails assessed in 'seated / handrail' section, but note that this does not include brackets which hold seat to ceiling handrails to seat back.
 - Handrails and associated brackets which hold partition structures with no or small protrusions < 3.2 mm and blunted / radiused edges, ideally radii >2.5 mm positioned in following head impact outer zones:
 - In-board seat, outer zone which is most inboard
 - Out-board seat, outer zone which is most outboard
 - Handholds (on high backed seats) in outer head impact zone with predominant radii > 10 mm
 - Stop buttons attached to seatback handrail with standard rounded design OR exposed radii > 2.5 mm
 - Window surrounds with predominant radii > 5 mm
 - Protrusions with height > 3.2 mm which meet UNECE Regulation No. 21 para 5.1.4 and/or 5.1.5 as appropriate – **manufacturer to provide documentary evidence**
 - Para 5.1.4.:Features made of rigid material, which project 3.2 mm to 9.5 mm from the surrounding structure, shall have a cross-sectional area of not less than 2 cm², measured 2.5 mm from the point projecting furthest, and shall have rounded edges with a radius of curvature of not less than 2.5 mm
 - Para 5.1.5Features made of rigid material, which project more than 9.5 mm from the surrounding structure, shall be so designed and constructed as to be able, under the effect of a longitudinal horizontal force of 378 N delivered by a flat-ended ram of not more than 50 mm in diameter, either to retract into the surface of the structure until they do not project by more







than 9.5 mm or to become detached; in the latter case, no dangerous projections of more than 9.5 mm shall remain; a cross section not more than 6.5 mm from the point of maximum projection shall be not less than 6.5 cm² in area.

- Note: for further detail see UNECE Regulation No 21⁴
- In body impact zone:
 - Edge / corner with predominant radii > 5 mm
 - Handrails and associated brackets with radii > 2.5mm which hold partitions USB port with standard rounded design OR exposed radii > 2.5 mm positioned at a height > 800 mm above the floor level where the seated passenger's feet rest
 - Protrusions with height > 3.2 mm which meet UNECE Regulation No. 21 para 5.1.4 and/or 5.1.5 as appropriate – **manufacturer to provide documentary evidence**
- 3. Identify groups of hazards which can be contained in a rectangular area 10 cm x 10 cm.
- 4. Count number of hazards identified for each zone; head inner, head outer, body; note that group of hazards as defined above shall be counted as one hazard only

Examples of potential hazards that should be included and excluded are shown on the following pages (Figure 34_17).

⁴ UNECE Regulation No 21: <https://op.europa.eu/en/publication-detail/-/publication/588aa860-5042-4063-ad75-8ae5e18af385/language-en>

Potential hazard included	Potential hazard excluded
 <p data-bbox="188 772 778 846">Sharp corner on Passenger Information System in head impact outer zone</p>	 <p data-bbox="802 730 1414 842">Full height glass partition in front of forward facing seats covering head impact zones</p>
 <p data-bbox="188 1290 746 1438">Luggage rack rail in head impact inner zone for rear facing seats (counts as 1 hazard in head impact inner zone for both seats, i.e. 2 hazards in total)</p>	 <p data-bbox="855 1267 1366 1344">Window surround with predominant radii > 5 mm</p>

Potential hazard included



Group of bolt heads in lower body impact zone (counts as 1 hazard for body impact zone because within 10 cm of each-other)

Potential hazard excluded



Stop button with rounded design



Ends of handrails in head impact outer zone of window seat passenger

Potential hazard included	Potential hazard excluded
 <p data-bbox="204 1048 766 1160">Sharp corners on notice / picture frame in head impact zones of passenger seat behind driver cab</p>	

Figure 34_17: Examples of potential hazards for seated passengers to be included and excluded in assessment



9 Assessment of results

9.1 Standing passengers

9.1.1 Handrails

9.1.1.1 Vertical

The boxes in the assessment template are scored as follows:

- a) A score of 0.1 is given for each Box A that a passenger could stand in and which:
- i. Has an unobstructed path to the handrail; and
 - ii. Presents no opportunity for the passenger to grab a secondary handrail.

Note: If any of these criteria are not met, the box is scored 0.

- b) A score of 0.2 is given for each Box B that a passenger could stand in and which:
- i. Has an unobstructed path to the handrail; and
 - ii. Presents no opportunity for the passenger to grab a secondary handrail.

Note: If any of these criteria are not met, the box is scored 0.

This results in maximum score of 1 for a handrail.

In the following situations this score is factored:

- a) In the case that a handrail does not have a length of 560 mm between the lower boundary of 1310 mm and upper boundary of 1870 mm, e.g. it is not vertical. In this case the length of the handrail projected into the Y plane (i.e. plane transverse across the bus) should be measured and a factor of (handrail length)/560 applied.
- b) In the case of handrails that curve away behind an obstruction (e.g. going further behind a row of seats), only those parts of the handrail within 250 mm of a longitudinal of the obstructing structure's outermost edge shall be considered within the zone. The length of handrail within the zone shall be measured and a factor of (handrail length)/560 applied.

9.1.1.2 Horizontal

1. Using the data collected, each handrail shall be assessed as follows:

- For handrail height ≤ 1200 mm score 0.
- For handrail height > 1200 mm and < 1340 mm, linearly score between 0 and 1 by application of formula below:

$$\text{Score} = (\text{'handrail height (mm)'} - 1160 \text{ mm}) / (1340 \text{ mm} - 1160 \text{ mm})$$
- For handrail height ≥ 1340 mm and ≤ 1755 mm, score 1
- For handrail height > 1755 mm and < 1870 mm, linearly score between 1 and 0 by application of formula below:

$$\text{Score} = (1870 \text{ mm} - \text{'handrail height (mm)'}) / (1870 \text{ mm} - 1755 \text{ mm})$$
- For handrail height ≥ 1870 mm score 0.

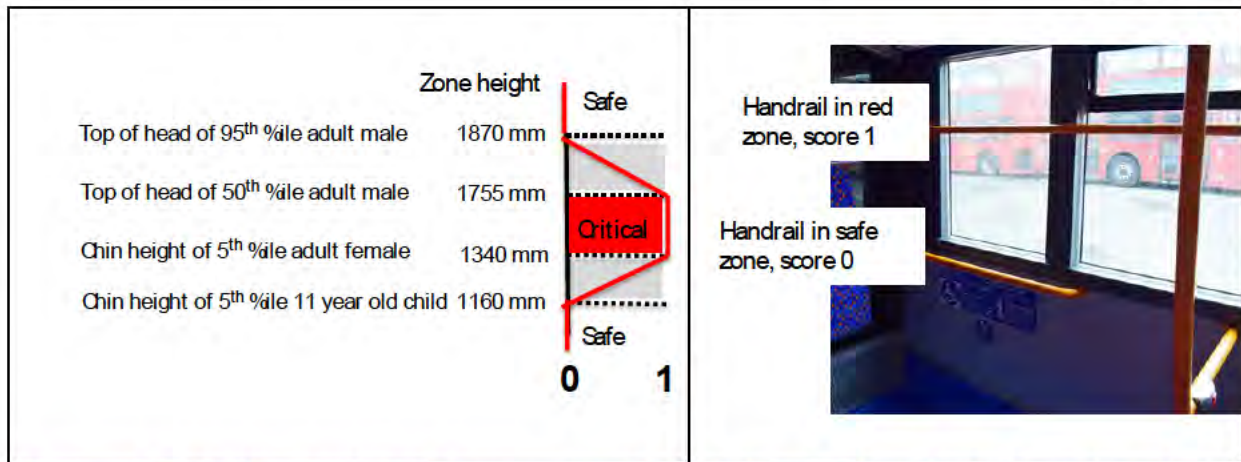

Figure 34_18: Illustration of assessment for horizontal handrails based on their height above the bus floor.

- The score for each handrail shall be factored per 500 mm length by application of the formula below:

$$\text{Score} = (\text{'handrail score'}) \times (\text{handrail length mm}) / 500 \text{ mm}$$

9.1.2 Restraint

The partition is scored based on its average height and length as below:

1. Partition average height

- 'Partition average height' \leq 750 mm score 1
- 'Partition average height' $>$ 750 mm and $<$ 1060 mm apply formula below:
 $\text{Score} = (1060 \text{ mm} - \text{'Partition average height (mm)}) / 310 \text{ mm} \times (\text{'Partition length (mm)}) / 500 \text{ mm}$
- Partition average height \geq 1060 mm score 0

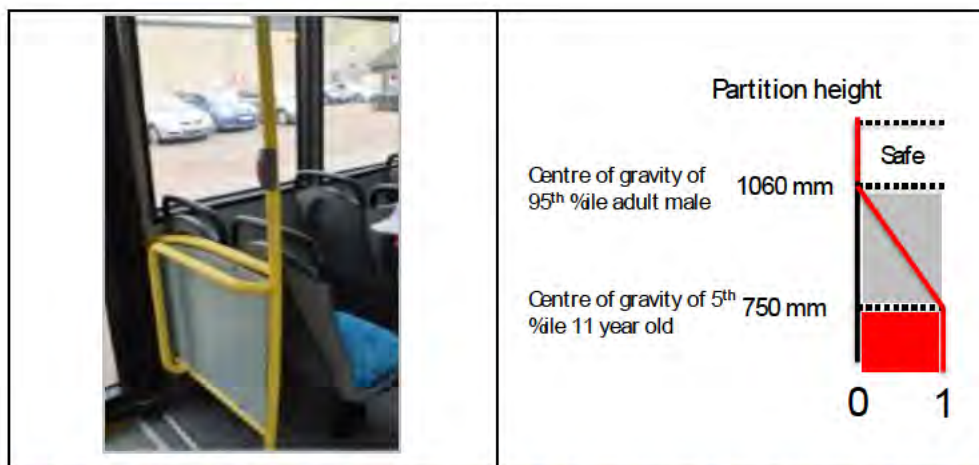

Figure 34_19: Illustration of assessment of restraint (partitions) for standing passengers.

2. The score for each partition shall be factored by its length by application of the formula below:

$$\text{Final score} = (\text{'Partition average height score'}) \times (\text{partition length mm}) / 500 \text{ mm}$$

Note: 500 mm chosen to represent approximate space required for one passenger to stand

9.1.3 General/other hazards

1. Each of the hazards and groups of hazards identified in Section 8.1.3 shall be assessed as follows:

If hazard or group of hazards has an edge or protrusion which meets the following criteria score 1 (otherwise score 0):

- Edge (see Figure 34_20):
 - Orientated laterally across the VUT within +/- 45 deg and has predominant radius less than 20 mm
 - Orientated longitudinally along the VUT within +/- 45 deg and has predominant radius less than 10 mm
- Protrusion:
 - Height greater than 3.2 mm (and not UNECE Regulation No. 21 para 5.1.4./5.1.5 compliant)

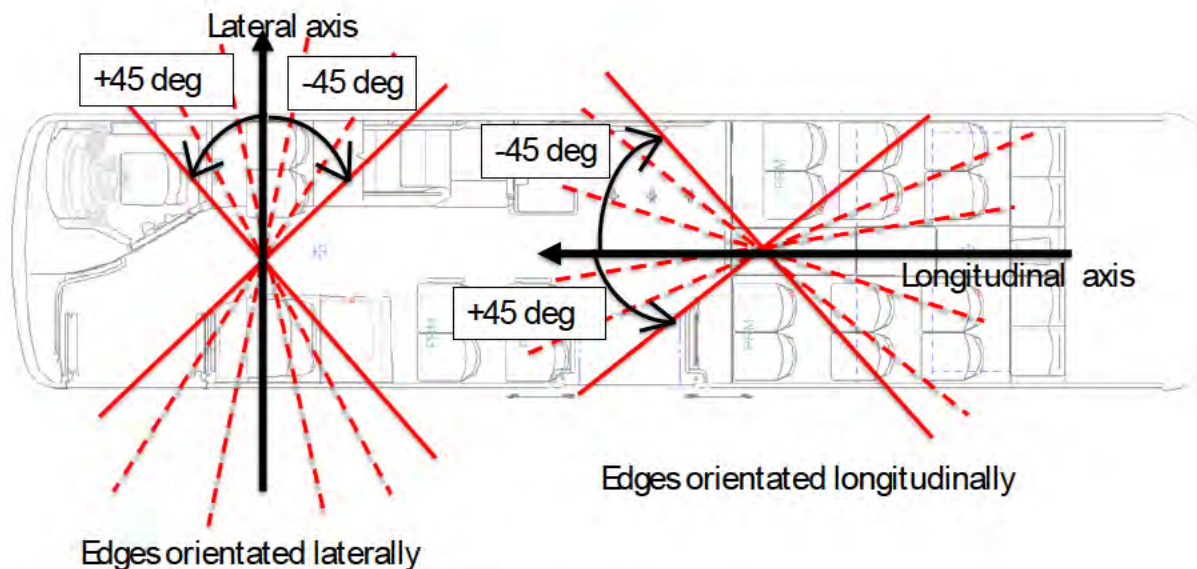

Figure 34_20: Illustration of laterally and longitudinally oriented edges (edges shown with dashed red lines, +/- 45 deg boundaries shown with solid red lines)

9.1.4 Weighting of hazards for standing passengers

The following weightings shall be applied to the scores for standing passengers:

- a) Handrails – multiply by 5
- b) Restraint – multiply by 4
- c) General / other hazards – multiply by 3

9.2 Seated passengers

9.2.1 Handrails

1. The handrail shall be scored as illustrated in Figure 34_21 as follows:

- i. If distance D_{LatHR} from the edge of the rail closest to the seat centre to the outer edge of the seat in the vehicles y-axis is ≤ 100 mm, handrail scores 0
- ii. If distance D_{LatHR} from the edge of the rail closest to the seat centre to the outer edge of the seat in the vehicles y-axis is $\geq ((W_{seat}/2) - 90$ mm), handrail scores 1
- iii. For distances in between those defined above, use the formula below to calculate a score between 0 and 1:

$$\text{Score} = (D_{LatHR} - 100 \text{ mm}) / (W_{seat}/2 - 190 \text{ mm})$$

2. For curved handrails:

- If D_{LatHR} measured at any height fulfils (ii) handrail scores 1 otherwise take average of D_{LatHR} measured at five heights and score as above for straight handrail, i.e. (i) or (iii)

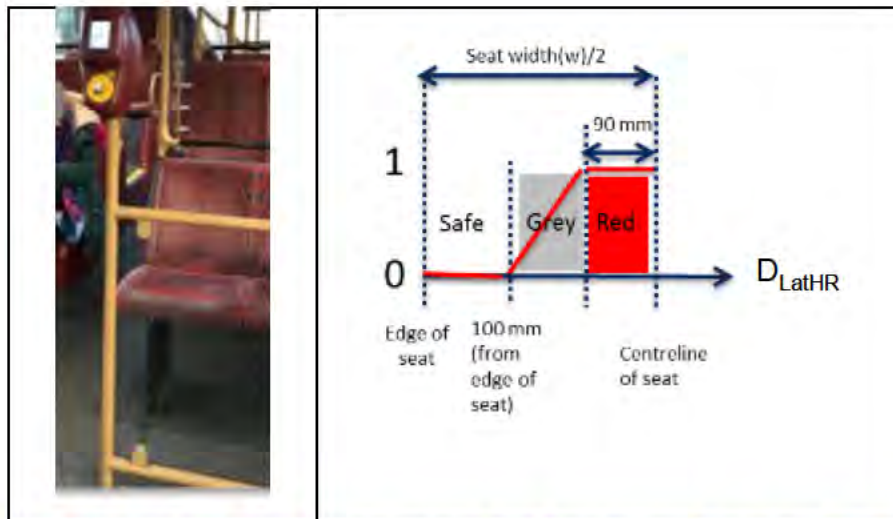

Figure 34_21: Procedure for assessment for handrails identified as a potential hazard for seated occupants



9.2.2 Restraint

1. The seats identified shall be assessed as follows:

- a) Seats with no or little structure in front of them (i.e. no partition like structure or other seats) shall be scored 1
- b) Bay seat arrangements shall be scored 0.75; note bay seat arrangement defined as defined as two sets of two seats facing each other – score for full arrangement (i.e. all 4 seats) is 0.75.
- c) Seats with some structure (partition like structure or other seats) in front of them shall be assessed as follows:

(a) The lateral coverage of the structure C_{Lat} shall be scored based on D_{LatRes} measurement as follows (see Figure):

- If $D_{LatRes} \leq 0$ mm $C_{Lat} = 1$;
- If $D_{LatRes} > 0$ mm and < 100 mm, $C_{Lat} = (100 - D_{LatRes})/100$
- If $D_{LatRes} \geq 100$ mm $C_{Lat} = 0$;

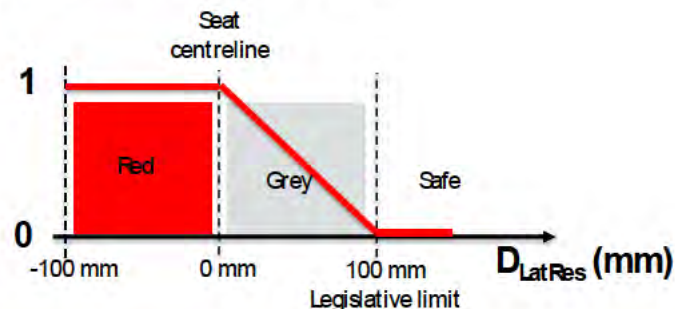

Figure 34_22: Illustration of safe, grey and red zones for lateral coverage of restraint assessment

(b) The average height (H_{feet}) as follows (see Figure):

- i. If the average height of the structure (H_{feet}) ≥ 800 , the structure's height is in the safe zone, height factor score = 0
- ii. If the average height of the structure (H_{feet}) ≤ 700 mm, the structure's height is in red zone, height factor score = 1.
- iii. If average height of structure (H_{feet}) is between 700 mm and 800 mm, the formula below shall be applied to calculate score between 0 and 1:

$$\text{Height factor score} = (800 - H_{feet})/100$$

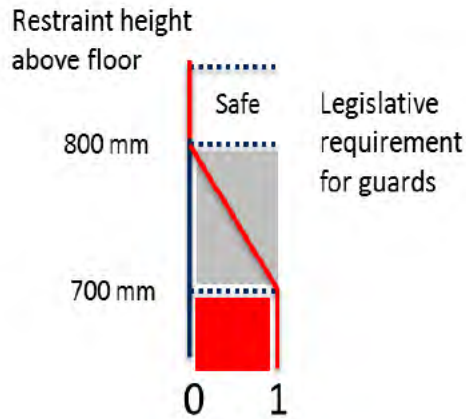

Figure 34_23: Illustration of safe, grey and red zones for height of restraint assessment

(c) The final score for the restraint shall be calculated based on its lateral coverage score (C_{Lat}) and its height factor score as follows:

$$\text{Final Score} = C_{Lat} + (\text{Height factor score})$$

Note: Scores calculated to be greater than 1 should be capped at 1.

Example: Assessment of restraint provided by wheel box / luggage area.

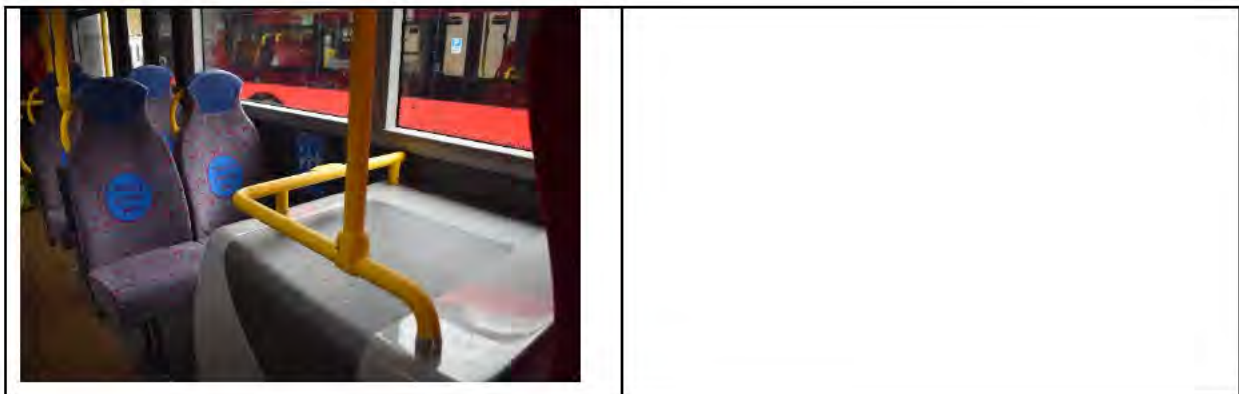

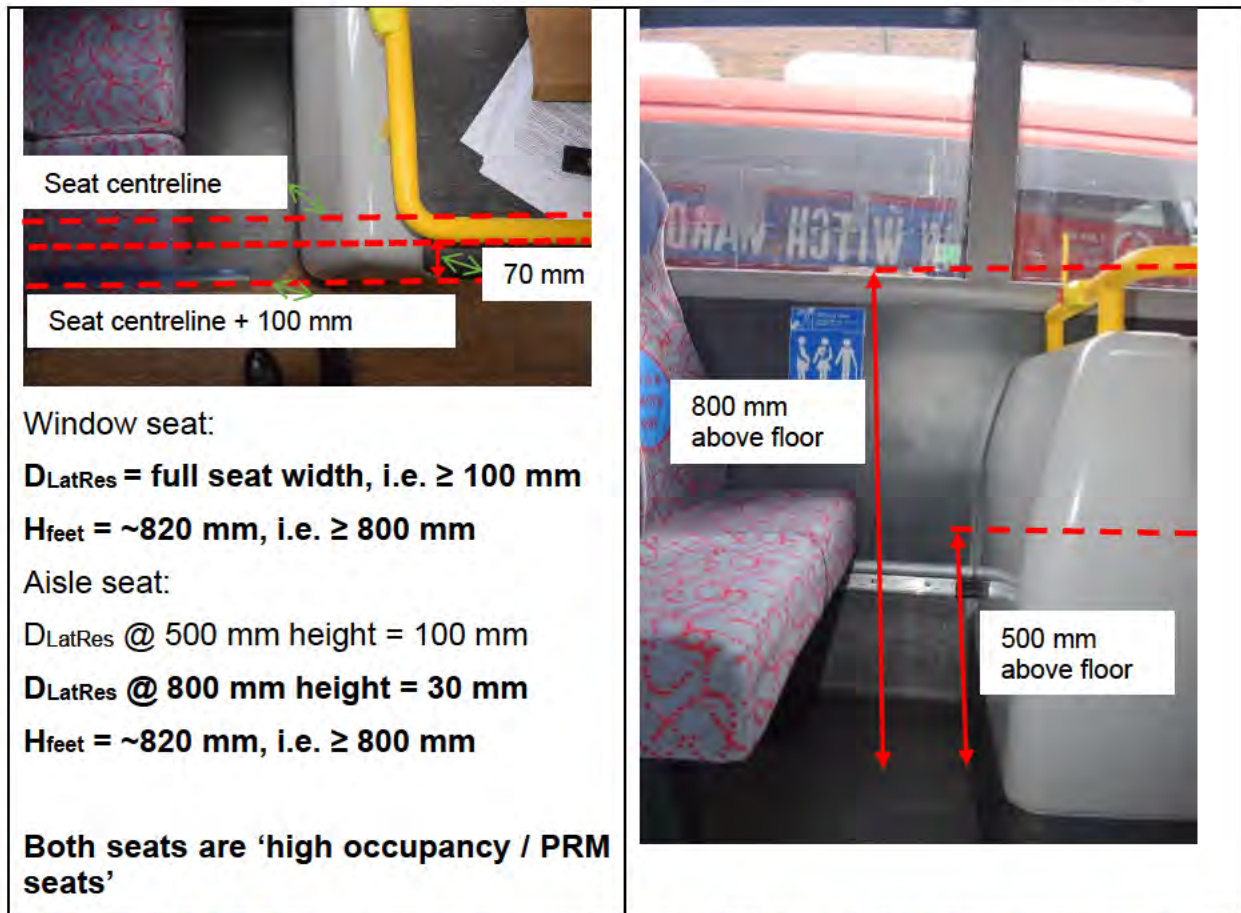

Window seat:

D_{LatRes} = full seat width, i.e. ≥ 100 mm

H_{feet} = ~ 820 mm, i.e. ≥ 800 mm

Aisle seat:

D_{LatRes} @ 500 mm height = 100 mm

D_{LatRes} @ 800 mm height = 30 mm

H_{feet} = ~ 820 mm, i.e. ≥ 800 mm

Both seats are 'high occupancy / PRM seats'

Figure 34_24: Assessment of restraint provided by wheel box / luggage area

Scoring of seats:

Window seat

- $D_{LatRes} \geq 100$ mm, therefore $C_{Lat} = 0$
- $H_{feet} \geq 800$, therefore score = $C_{Lat} = 0$

Aisle seat

- $D_{LatRes} = 30$ mm, therefore $C_{Lat} = (100 - 30)/100 = 0.7$
- $H_{feet} \geq 800$, therefore score = $C_{Lat} = 0.7$

Note: Seat is 'high occupancy/ PRM seat', so weighting applied is 8 (see Section 9.2.4).

9.2.3 General/other hazards

For each seat position, an assessment of the injury potential and risk of impact shall be made for the hazards (and groups of hazards) identified and a score of up to 1.0 given, in accordance with the following criteria (see Figure for definition of impact zones, head inner, head outer and body):

Injury potential:

- Head impact categorise as high
- Other body region impact categorise as low



Risk of impact:

- Hazard located in head impact inner zone; categorise as high
 - Note: if any part of hazard in head inner zone; score it as high
- Hazard located in head impact outer zone; categorise as low
- Hazard located in body impact zone; categorise as low

Score:

- Injury potential low, risk of impact low; score 0.3
- Injury potential high, risk of impact low and vice versa; score 0.6
- Injury potential high, risk of impact high; score 1.0

9.2.4 **Weighting of assessment category scores for seated passengers**

The following weightings shall be applied to assessment category scores not associated with 'high occupancy / PRM' seats:

- a) Handrails – multiply by 5
- b) Restraint – multiply by 4
- c) General / other hazards – multiply by 4

For 'high occupancy / PRM' seats, the following weighting shall be applied:

- a) Handrails – multiply by 10
- b) Restraint – multiply by 8
- c) General / other hazards – multiply by 8

10 **Assessment template**

Each of the scores shall be entered into an assessment template made up of the tables shown in Appendix A - Assessment Template.

The Total Actual Score is the sum of the weighted scores for each assessment section, which are highlighted yellow. A separate value shall be calculated for the lower saloon, the upper saloon and the vehicle as a whole.

11 **Normalising the score**

The basic score system above produces a higher score the greater the number of hazards identified and, theoretically, there is no upper limit to the score. Ideally the score would be zero with no identified hazards.

In order to incorporate the interiors score within an overall bus safety score, it is necessary to 'normalise' this score to a value between 0% and 100%, where 0% represents the worst vehicles and 100% the best.

In order to do this a maximum points ceiling shall be set at 120 points for the lower saloon and 12 points for the upper saloon. Thus, the overall maximum score is 120 points for a single deck vehicle and 132 points for a double deck vehicle.



A Total Limited Score shall be defined for the lower saloon, the upper saloon and the vehicle as a whole and shall be the lesser of the Total Actual Score and the Maximum score.

The Normalised Score for lower saloon, upper saloon and whole vehicle shall be calculated according to the formula $1 - (\text{Total Limited Score} / \text{Maximum Score})$ and expressed as a percentage.

12 Test report

The Test Service shall provide a comprehensive test report that will be made available to the Approval Authority. The test report shall consist of the following distinct sections:

- a) Confirmation of protocol compliance
- b) Reference information.

To confirm protocol compliance, the Test Service shall include in the report the completed Occupant Friendly Interiors Assessment worksheet

The reference information required includes as a minimum:

- a) Vehicle make;
- b) Vehicle model;
- c) Vehicle model variant;
- d) Details of the Test Service; and
- e) Test date(s).



Appendix A - Assessment Template

Note: Values entered in the tables below are fictional values for illustrative purposes only.

Section 1. Standing Passengers											Weighted	
Handrails - Vertical	Length Factor	Box A's (Max 0.1 each)					Box B's (Max 0.2 each)		Total	Weighted		
		Score	Score	Score	Score	Score	Score	Score				
Handrail 1	1.00	0.10							0.10	5		
Handrail 2	1.00	0.10	0.10					0.20	0.40			
Handrail 3	1.23	0.10	0.10					0.20	0.49			
Handrail 4	1.00	0.10							0.10			
Handrail 5	1.00	0.10	0.10	0.10				0.20	0.50			
Handrail 6	1.00	0.10	0.10	0.10	0.10			0.20	0.60			
Handrail 7	1.00	0.10	0.10	0.10				0.20	0.50			
Handrail 8	0.00								0.00			
Handrail 9	1.00	0.10	0.10					0.20	0.40			
Handrail 10	1.00	0.10	0.10					0.20	0.40			
Handrail 11	1.00	0.10						0.20	0.30			
Handrail 12	1.00	0.10						0.20	0.30			
Handrail 13									0.00			
Handrail 14									0.00			
Handrail 15									0.00			
Handrail 16									0.00			
Handrail 17									0.00			
Handrail 18 (for more add rows)									0.00			
For handrail curved in bus Y plane: Length Factor = (Length in mm between 1310 mm and 1870 mm from floor)/500;												
For straight handrails Length Factor = 1.0												
For handrail that curves behind obstruction: Length Factor = (Length in mm between 1310 mm and 1870 mm from floor AND < 250 mm from edge of obstruction)/500												
Handrails - Horizontal	Height Factor	Length Factor								Total	20.80	
Handrail 1	1.00	4.16								4.16	5	
Handrail 2										0.00		
Handrail 3										0.00		
Handrail 4										0.00		
Handrail 5										0.00		
Handrail 6 (for more add rows)										0.00		
Height factor - red zone (IF rail ≥ 1340 mm from floor AND rail ≤ 1755 mm) = 1												
Height factor - upper grey zone (IF rail between 1755 mm and 1870 mm from floor) = (1870 - 'height of rail from floor in mm')/115												
Height factor - lower grey zone (IF rail between 1200 mm and 1340 mm from floor) = ('height of rail from floor in mm' - 1200)/180												
Height factor - safe zones (IF rail 1870 mm from floor OR 1180 mm from floor) = 0												
Length Factor = (Length in mm)/500												
Restraint	Average Height Factor	Length Factor								Total	3.84	
Restraint 1	0.48	2.00								0.96	4	
Restraint 2										0.00		
Restraint 3										0.00		
Restraint 4										0.00		
Restraint 5										0.00		
Restraint 6 (for more add rows)										0.00		
Average height factor - red zone (IF partition average height ≤ 750 mm from floor) = 1												
Average height factor - grey zone (IF partition average height between 750 mm and 1060 mm from floor) = (1060 - 'partition average height from floor in mm')/310												
Average height factor - safe zone (IF partition average height ≥ 1060 mm from floor) = 0												
Length Factor = (Length in mm)/500												
General/Other	Score (0 or 1)								Total	3.00		
Hazard 1	1.00								1.00	3		
Hazard 2									0.00			
Hazard 3									0.00			
Hazard 4									0.00			
Hazard 5									0.00			
Hazard 6									0.00			
Hazard 7									0.00			
Hazard 8									0.00			
Hazard 9									0.00			
Hazard 10 (for more add rows)									0.00			
Section 2. Seated Passengers (Lower Deck)												
Handrails - Vertical	Lateral factor	Position	PRM/High Occupancy seat? (Y/N)	Number of additional Identical Seats						Total	27.14	
Handrail 1	1.00		Y	0						2.00	5	
Handrail 2	0.00		Y	1						0.00		
Handrail 3	1.00		Y	0						2.00		
Handrail 4	0.71		N	1						1.43		
Handrail 5										0.00		
Handrail 6										0.00		
Handrail 7										0.00		
Handrail 8										0.00		
Handrail 9										0.00		
Handrail 10										0.00		
Handrail 11										0.00		
Handrail 12 (for more add rows)										0.00		
Lateral position factor - safe zone (IF distance edge of rail nearest to seat centreline to outer edge of seat in mm (DLatHR) ≥ ('half seat width in mm' (w/2) - 90) = 1												
Lateral position factor - red zone (IF distance edge of rail nearest to seat centreline to outer edge of seat in mm (DLatHR) ≤ 100) = 0												
Lateral position factor - grey Zone (IF distance edge of rail nearest to seat centreline to outer edge of seat in mm (DLatHR) > 100 AND < ('half seat width in mm' (w/2) - 90) = (DLatHR - 100)/(w/2 - 190)												



Restraint Hazards	Exposed Seat? (Y/N)	Bay Seat? (Y/N)	Lateral Coverage Factor (CLat)	Height Factor	PRM/High Occupancy seat? (Y/N)	Number of Identical Seats	Total	18.00
Restraint 1	Y	N			Y		2.00	4
Restraint 2	Y	N			N		1.00	
Restraint 3	N	Y			N		0.75	
Restraint 4	N	Y			N		0.75	
Restraint 5							0.00	
Restraint 6 (for more add rows)							0.00	

Score 1 if seat facing directly into aisle or other empty space, i.e. exposed seat

Score 0.75 for set of 4 bay seats

If some restraint present, score lateral coverage and height factors as follows:

- Lateral coverage factor - red zone (IF lateral coverage from seat centreline (DLatRes) ≤ 0 mm, CLat = 1
- Lateral coverage factor - safe zone (IF lateral coverage from seat centreline (DLatRes) ≥ 100 mm, CLat = 0
- Lateral coverage factor - safe zone (IF lateral coverage from seat centreline (DLatRes) > 0 and < 100 mm, CLat = (100 - DLatRes)/100
- Height factor - red zone (IF average height of restraint above floor in mm (Hfeet) ≤ 700 mm) = 1
- Height factor - safe zone (IF average height of restraint above floor in mm (Hfeet) ≥ 800 mm) = 0
- Height factor - grey zone (IF average height of restraint above floor in mm (Hfeet) > 700 mm and < 800 mm) = (800 - Hfeet)/100
- Final score = CLat + Height factor **Note final score capped at 1, i.e. if > 1 = 1**

General/Other	Score (0.3, 0.6 or 1)	PRM/High Occupancy seat? (Y/N)	Number of additional Identical Seats	Total	0.00
Hazard 1	0.00			0.00	4
Hazard 2				0.00	
Hazard 3				0.00	
Hazard 4				0.00	
Hazard 5				0.00	
Hazard 6				0.00	
Hazard 7				0.00	
Hazard 8 (for more add rows)				0.00	

Injury potential: Head impact high; Other body regions low

Risk of impact:

- a) Hazard located in head impact inner zone categorise as high
- b) Hazard located in head impact outer zone categorise as low
- c) Hazard located in body impact zone categorise as low

Score:

- i. Injury potential low, risk of impact low; score 0.3
- ii. Injury potential high, risk of impact low and vice versa; score 0.6
- iii. Injury potential high, risk of impact high; score 1.0

Section 3. Seated Passengers (Upper Deck)

Handrails - Vertical	Lateral Position Factor	Number of additional Identical Seats	Total	3.00
Handrail 1	0.00	7	0.00	5
Handrail 2	0.60	0	0.60	
Handrail 3			0.00	
Handrail 4			0.00	
Handrail 5			0.00	
Handrail 6			0.00	
Handrail 7			0.00	
Handrail 8			0.00	
Handrail 9			0.00	
Handrail 10			0.00	
Handrail 11			0.00	
Handrail 12 (for more add rows)			0.00	

Lateral position factor - red zone (IF distance edge of rail nearest to seat centreline to outer edge of seat in mm (DLatHR) ≥ (half seat width in mm' (w/2) - 90) = 1

Lateral position factor - safe zone (IF distance edge of rail nearest to seat centreline to outer edge of seat in mm (DLatHR) ≤ 100) = 0

Lateral position factor - grey Zone (IF distance edge of rail nearest to seat centreline to outer edge of seat in mm (DLatHR) > 100 AND < (half seat width in mm' (w/2) - 90) = (DLatHR - 100)/(w/2 - 190)

Restraint	Exposed Seat? (Y/N)	Bay Seat? (Y/N)	Lateral Coverage Factor (CLat)	Height Factor	Number of additional Identical Seats	Total	4.00
Restraint 1	Y	N			0	1.00	4
Restraint 2						0.00	
Restraint 3						0.00	
Restraint 4						0.00	
Restraint 5						0.00	
Restraint 6 (for more add rows)						0.00	

Score 1 if seat facing directly into aisle or other empty space, i.e. exposed seat

Score 0.75 for set of 4 bay seats

If some restraint present, score lateral coverage and height factors as follows:

- Lateral coverage factor - red zone (IF lateral coverage from seat centreline (DLatRes) ≤ 0 mm, CLat = 1
- Lateral coverage factor - safe zone (IF lateral coverage from seat centreline (DLatRes) ≥ 100 mm, CLat = 0
- Lateral coverage factor - safe zone (IF lateral coverage from seat centreline (DLatRes) > 0 and < 100 mm, CLat = (100 - DLatRes)/100
- Height factor - red zone (IF average height of restraint above floor in mm (Hfeet) ≤ 700 mm) = 1
- Height factor - safe zone (IF average height of restraint above floor in mm (Hfeet) ≥ 800 mm) = 0
- Height factor - grey zone (IF average height of restraint above floor in mm (Hfeet) > 700 mm and < 800 mm) = (800 - Hfeet)/100
- Final score = CLat + Height factor **Note final score capped at 1, i.e. if > 1 = 1**



General/Other	Score (0.3, 0.6 or 1)	Number of additional Identical Seats		Total	0.00
Hazard 1	0.00	0		0.00	4
Hazard 2				0.00	
Hazard 3				0.00	
Hazard 4				0.00	
Hazard 5				0.00	
Hazard 6				0.00	
Hazard 7				0.00	
Hazard 8 (for more add rows)				0.00	
Injury potential: Head impact high; Other body regions low Risk of impact: <ul style="list-style-type: none"> - Hazard located in head impact inner zone categorise as high - Hazard located in head impact outer zone categorise as low - Hazard located in body impact zone categorise as low Score: <ol style="list-style-type: none"> i. Injury potential low, risk of impact low; score 0.3 ii. Injury potential high, risk of impact low and vice versa; score 0.6 iii. Injury potential high, risk of impact high; score 1.0 					



Attachment 35: Occupant Friendly Interiors Guidance Notes

1 Introduction

This document sets out the guidance notes related to occupant friendly interiors and the bus interior safety assessment protocol, Attachment 34. These guidance notes are aimed at bus operators and OEMs as a practical guide for implementation of the Bus Safety Standard.

These notes are for guidance only and are not legally binding. In all circumstances, the guidance provided by an OEM or system supplier shall take precedence, and these guidance notes are only for use in the absence of other information. These are not intended to be exhaustive, but to point the operators toward practical advice and questions to raise with OEMs/suppliers.

Any modifications to the bus interior which have been either stipulated or conducted by the bus operator must be included in any assessment following the procedure defined in Attachment 35: Occupant Friendly Interiors Assessment Protocol, such that the assessment is completed on a bus in an “in service” condition.

2 Approach

2.1 Overall

The bus interior safety assessment protocol involves the identification and assessment of bus interior potential hazards (i.e. features that have injury causing potential) present in three categories; handrail, restraint and general (for standing and seated passengers), as shown diagrammatically in Figure . The assessment gives points for each potential hazard identified. More points are given for hazards which have greater injury causing potential and greater exposure (e.g. hazards associated with seats that are likely to be used more often). The aim is to encourage OEMs to have as few potential hazards as possible and therefore score the minimum number of points, i.e. a lower score correlates with a better assessment.

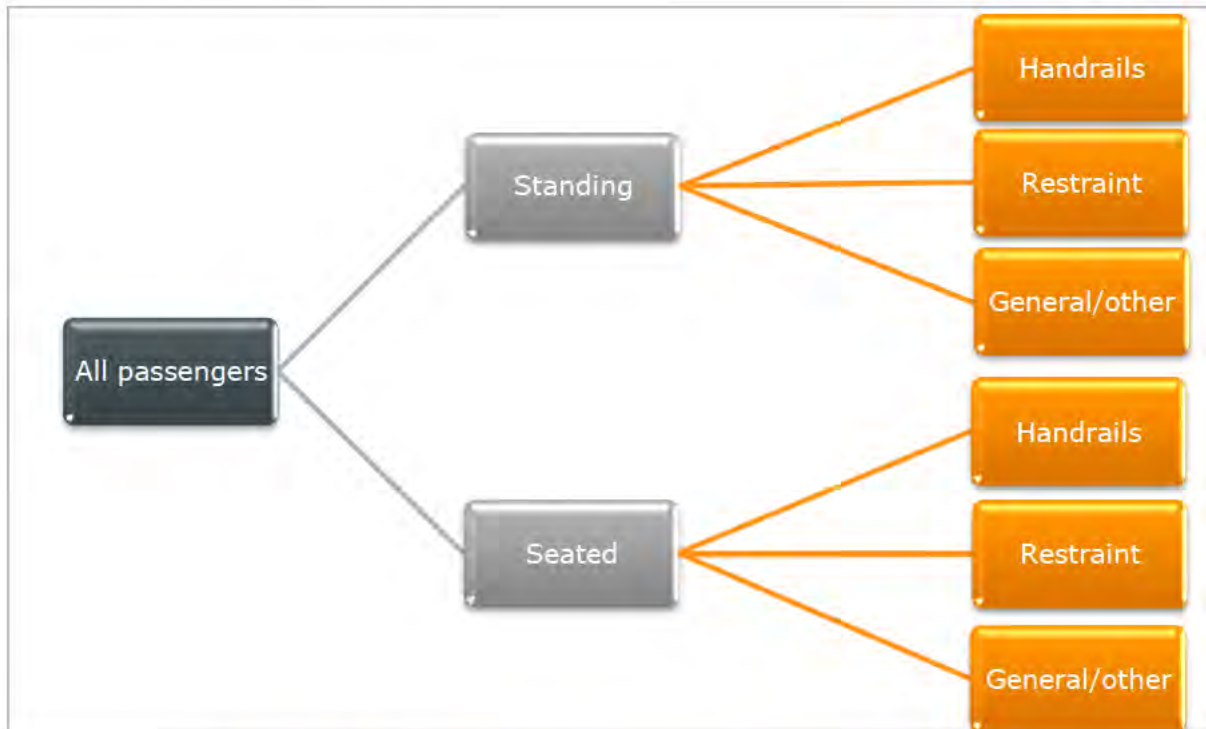

Figure 35_1: Visual inspection hazard categories

The purpose of each of the inspection categories is described below:

Standing: handrails

- To encourage vertical handrails to be positioned where they are less likely to be hit by a falling passenger
- To discourage the placement of horizontal handrails at a height, level with a passenger's head, where they are likely to be impacted

Standing: restraint:

- To encourage partitions that a passenger may stand behind to be of sufficient height to restrain the motion of a passenger in the event of harsh braking and / or a collision, i.e. they are not thrown over it

Standing general:

- To encourage the removal of features, such as sharp edges / corners and protrusions, that a standing passenger may hit when they fall, with focus on head impact.

Seated: handrails

- To encourage vertical handrails (mainly seat back to ceiling) to be positioned more inboard to reduce the risk of head impact for seated passengers

Seated restraint:

- To encourage structures in front of seated passengers (partitions or seatbacks) to have sufficient height and width to constrain passenger motion during harsh braking or a collision type event, i.e. they are not thrown over or around side of structure.



Seated general:

To encourage the removal of features, such as sharp edges / corners and protrusions, that a seated passenger may hit mainly when they are thrown forward during harsh braking or a collision type event.

2.2 Procedure

The procedure to perform an inspection and assessment is as follows:

- Identify and count potential hazards in each category for standing and seated passengers.
- Scale individual potential hazards according to passenger exposure. This step is also used to avoid discontinuities in the assessment system. To help understanding of this step, an example of the scaling for horizontal handrails, for standing passengers, is given below in Section 2.2.1.
- Weight the score for each potential hazard identified in each of the six categories and sum them to give overall point scores for the lower deck and, if applicable, the upper deck.

Weightings are applied to reflect the following:

- a) The injury potential of the hazard, e.g. if the hazard is likely to cause a head injury as opposed to a lower limb injury, a higher weighting is given.
- b) Exposure of the hazard, e.g. if the hazard is in an area of the bus with a higher occupancy rate, a higher weighting is given. Also, additional weighting is applied to hazards to which persons with reduced mobility (PRM) are likely to be exposed. This is because, generally, PRM have slower reaction times and are less tolerant to injury, which can increase their likelihood of impacting a hazard and being injured.

2.2.1 Example: Standing occupants – Horizontal handrails

Horizontal handrails can be positioned where they may be hit by a standing passenger's head, when that passenger falls. The likelihood of this occurring depends on the height of the rail. The more the rail is in alignment with a passenger's head, the more likely it is that it will be hit. To account for this and to avoid discontinuities, a sliding scale scoring system has been developed that gives a score ranging from 0 to 1. This results in red, grey and safe zones as illustrated in the left hand side of Figure 35_2 **Error! Reference source not found.** below.

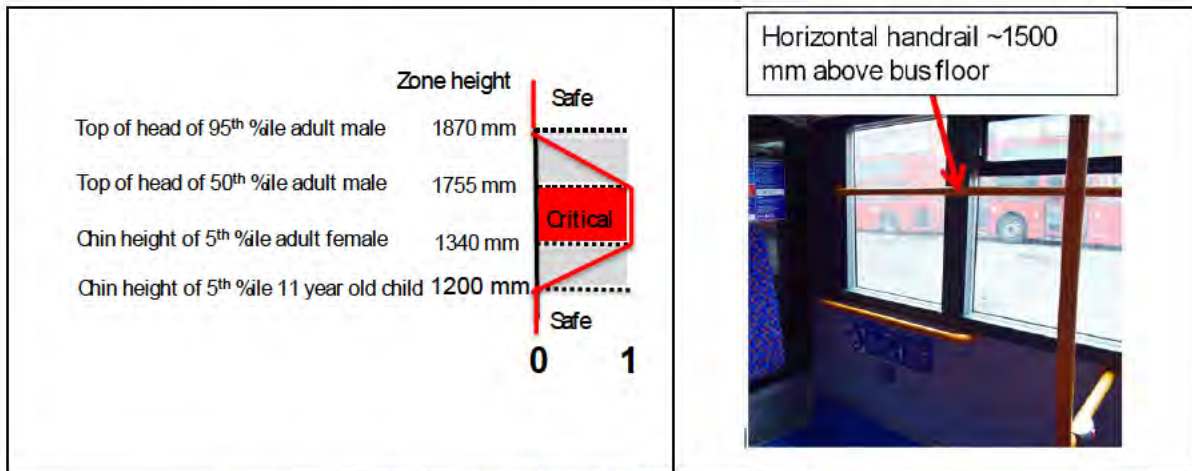

Figure 35_2: Illustration of Handrail safe zones

The red zone is positioned between 1340 mm (height of chin of 5th percentile female) and 1755 mm (height of top of head of 50th percentile male). Therefore a passenger is likely to hit their head on a rail positioned at this height. Hence, a score of 1 (per unit length) is given for a horizontal rail positioned within this zone.

The grey zones are positioned above and below the red zone using a sliding scale as the proportion of the population reduces. Hence, a score linearly reducing from 1 to 0 per unit of length is given for a rail positioned in this zone depending on the precise height of its centre. For example a rail with a top edge height of 1800 mm would be scored $(1870 - 1800)/(1870 - 1755) = 0.61$ per unit length.

The bottom grey zone is positioned between 1340 mm (height of chin of 5th percentile female) and 1200 mm (height of chin of 5th percentile 11-year-old child). A similar argument applies and approach is taken for this zone as for the top grey zone.

The safe zones are positioned above and below the grey zones. These zones are above 1870 mm (top safe zone) and below 1200 mm (bottom safe zone). The head height of a small proportion of the population will be in these zones. Therefore, a score of zero is given for rails positioned in these zones.

The unit length chosen was 500 mm on the basis that this is approximately the space taken up by one passenger standing, or leaning against the side of the bus.

Note: It can be seen that if an OEM decides to change the height of a horizontal handrail by a small amount, say 10 mm, then the score will only change a small amount to reflect this, i.e. there are no discontinuities in the assessment system with the sliding scale approach.

3 Selection of buses/systems

A bus interior safety assessment should be carried out on each different bus model and variant in a 'ready for service' condition, i.e. with additional items such as TfL iBUS modules fitted. This assessment should be carried out by a TfL nominated supplier.

It is expected that OEMs will wish to achieve given interior safety assessment values as targets for new bus designs. Therefore, they will need to be able to estimate the assessment values for potential designs throughout the design process. For these



reasons, the assessment protocol has been kept as simple as possible (it is based mainly on simple measurements), so that it should be easily possible to perform an assessment based on 3D CAD information.

4 Training

Training and consultancy related to carrying out a bus interior assessment should be provided by a TfL nominated supplier.

5 Retro-fitment of additional items

Following the assessment of a bus model / variant in a 'service ready' condition by a TfL nominated supplier, additional items which alter the assessment should not be fitted to the bus (e.g. by operators). If it is necessary to fit items, which may alter the assessment, TfL should be consulted.



Attachment 36: VRU Frontal Crashworthiness Energy Absorption Assessment Protocol

1 Introduction

This document presents a protocol, hereon referred to as the Bus VRU Frontal Crashworthiness Energy Absorption Assessment Protocol, for assessment of the front-end of a bus to measure the impact protection provided by it, the front end of a bus in the event of a collision with a vulnerable road user (VRU); in particular, when striking their head.

For full understanding of this Attachment it should be read in conjunction with the Attachment 37: VRU Frontal Crashworthiness Energy Absorption Guidance Notes and New Bus Specification, Section 4.6.3.

2 Scope

This protocol applies to all new buses intended for service under contract to TfL that are passenger vehicles with a maximum mass exceeding 5 tonnes and a capacity exceeding 22 passengers. The passenger vehicles will be capable of carrying seated but unrestrained occupants and standing occupants. Such vehicles are categorised the Consolidated Resolution on the Construction of Vehicles (R.E.3) as M₃; Class I.

3 Purpose

The purpose of this test and assessment protocol is to bring about an improvement in the construction of certain components of the front end of buses which have been identified as causing injury when in collision with a pedestrian's, or other vulnerable road user's, head.

The vehicles that will be tested under the Bus VRU Frontal Crashworthiness Energy Absorption Assessment Protocol are representative of the majority of buses in circulation in the urban environment, where there is a significant potential for bus collisions with pedestrians and other vulnerable road users.

4 Normative References

The following normative documents, in whole or in part, are referenced in this document and are indispensable for its application. For dated references, only the edition cited applies. For undated references, the latest edition of the referenced document (including any amendments) applies.

- London Bus Service Limited New Bus Specification Section 4.6.3



- London Bus Service Limited New Bus Specification – Attachment 37: Bus Impact Test Standard Guidance Notes
- Directive 2007/46/EC of the European Parliament and of the Council establishing a framework for the approval of motor vehicles and their trailers, and of systems, components and separate technical units intended for such vehicles.
- International Standard ISO 384:1976. Road vehicles – Measurement of impact velocity in collision tests
- International Standard ISO 6487:2015. Road vehicles – Measurement techniques in impact tests – Instrumentation
- UN Regulation No. 127.02 Uniform provisions concerning the approval of motor vehicles with regard to their pedestrian safety performance.
 - <https://eur-lex.europa.eu/eli/reg/2020/638/oj>

5 Definitions

For the purpose of this protocol:

- **Adult head-form** - is the test tool used to represent the head of an adult in these impact tests. It is identical to that specified in UN Regulation No. 127.02, Annex 4 'test impactor specifications', Section 5 'Child and Adult head-form impactors'.
- **Adult head-form test zone** - is an area on the outer surfaces of the front structure. The area is bounded:
 - a) At the lower edge, by a Wrap Around Distance (WAD) of 1,500mm from the ground reference plane (with the vehicle at its nominal ride attitude) (WAD1500);
 - b) At the upper edge, by a WAD of 1,850 mm from the ground reference plane (with the vehicle at its minimum ride attitude) (WAD1850); and
 - c) At each side, by a line 82.5 mm inside the side reference line. The distance of 82.5 mm is to be set with a flexible tape held tautly parallel to the horizontal plane of the vehicle and along the outer surface of the vehicle.
- **A-pillar** - means the foremost and outermost roof support extending from the chassis to the roof of the vehicle.
- **Atypical windscreen fracture** is where the head-form to windscreen impact results in at least one of the following cases:
 - (a) The minimum value of the derivation of the head-form acceleration versus time is greater than -180 g/ms within the first 4 ms after the initial contact of the head-form to the windscreen; or
 - (b) The minimum value of the acceleration below 300 m/s² between the initial peak and 10 milliseconds is reached later than 4 ms in the time/acceleration plot, or glass breaking which expands to a large part of the windshield is not visibly observed.



- For further information about this definition and its application please see the guidance notes, section 2.1.4.
- **Bus front end** - means all outer structures of the front end of the vehicle exposed to a potential collision with a VRU. It may therefore include, but is not limited to, the bumper, the bonnet or grille, scuttle, wiper spindles, lower windscreen frame, the windscreen, the windscreen header and the A-pillars.
- **Child head-form** - is the test tool used to represent the head of a child in these impact tests. It is identical to that specified in UN Regulation No. 127.02, Annex 4 'test impactor specifications', Section 5 'Child and Adult head-form impactors'.
- **Child head-form test zone** - is an area on the outer surfaces of the front structure. The area is bounded:
 - a) At the lower edge, by a WAD of 1,115 mm from the ground reference plane (with the vehicle at its maximum ride attitude) (WAD1115);
 - b) At the upper edge, by a WAD 1,500 mm from the ground reference plane (with the vehicle at its nominal ride attitude) (WAD1500); and
 - c) At each side, by a line 82.5 mm inside the side reference line. The distance of 82.5 mm is to be set with a flexible tape held tautly parallel to the horizontal plane of the vehicle and along the outer surface of the vehicle.
- **Driver mass** - means the nominal mass of a driver that shall be [68] kg.
- **Ground reference plane** - means a horizontal plane, either real or imaginary, that passes through the lowest points of contact for all tyres of a vehicle. If the vehicle is resting on the ground, then the ground level and the ground reference plane are one and the same. If the vehicle is raised off the ground such as to allow extra clearance, then the ground reference plane is above ground level; and if the vehicle (perhaps a test sample) is lower than it would be in running order, then the ground reference plane is below the ground level.
- **Head Injury Criterion (HIC₁₅)** - means the calculated result of accelerometer time histories over a maximum recording period of 15 milliseconds using the following formula:

$$HIC_{15} = \left[\frac{1}{t_2 - t_1} \int_{t_1}^{t_2} a \, dt \right]^{2.5} (t_2 - t_1)$$

Where:

“a” is the resultant acceleration measured in units of gravity “g” (1 g = 9.81 m/s²);

“t1” and “t2” are the two time instants (expressed in seconds) during the impact, defining an interval between the beginning and the end of the recording period for which the value of HIC is a maximum (t₂ - t₁ ≤ 15 ms).

- **Mass in running order** - means the nominal mass of a vehicle as determined by the sum of the unladen vehicle mass and driver’s mass.



- **Maximum ride attitude** - means the vehicle positioned on a flat horizontal surface with its mass in running order, with the tyres inflated to OEM recommended pressures, the front wheels in the straight-ahead position. The suspension shall be set in normal running condition as specified by the OEM for a speed of 40 km/h.
- **Minimum ride attitude** - means the vehicle positioned on a flat horizontal surface (as per the maximum ride attitude, but) with its mass increased to gross vehicle mass; the maximum mass of the fully laden vehicle based on its construction and design performances, as declared by the OEM. This shall be less than or equal to the sum of the maximum axles' (group of axles) capacity. The suspension shall be set in the running condition for this condition as specified by the OEM for a speed of 40 km/h.
- **Nominal ride attitude** - means the vehicle positioned at the mid-point of the maximum and minimum ride attitudes.
- **OEM: Original Equipment Manufacturer** – The company responsible for the manufacture of a completed bus, delivered to a bus operator
- **Primary reference marks** - means holes, surfaces, marks and identification signs on the vehicle body. The type of reference mark used and the vertical (Z) position of each mark relative to the ground shall be specified by the OEM according to the running conditions specified along with the Minimum, Maximum and Nominal ride attitudes. These marks shall be selected so as to be able to easily check the vehicle front and rear ride heights and vehicle attitude.
- **Side reference line** - means the geometric trace of the highest points of contact between a straight edge 700mm long and the sides of the vehicle, when the straight edge, held parallel to the transverse horizontal plane of the vehicle and inclined rearwards by [60°], is traversed rearwards, and maintains contact with the sides of the bus front end (Figure 36_1a and Figure 36_1b).

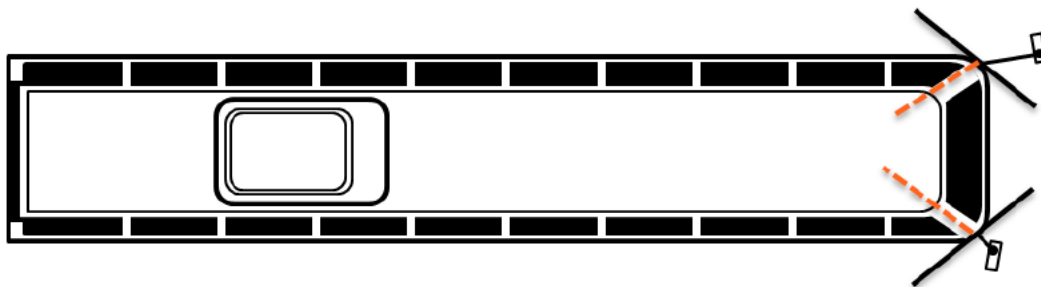

Figure 36_1a: Side reference line – plan view

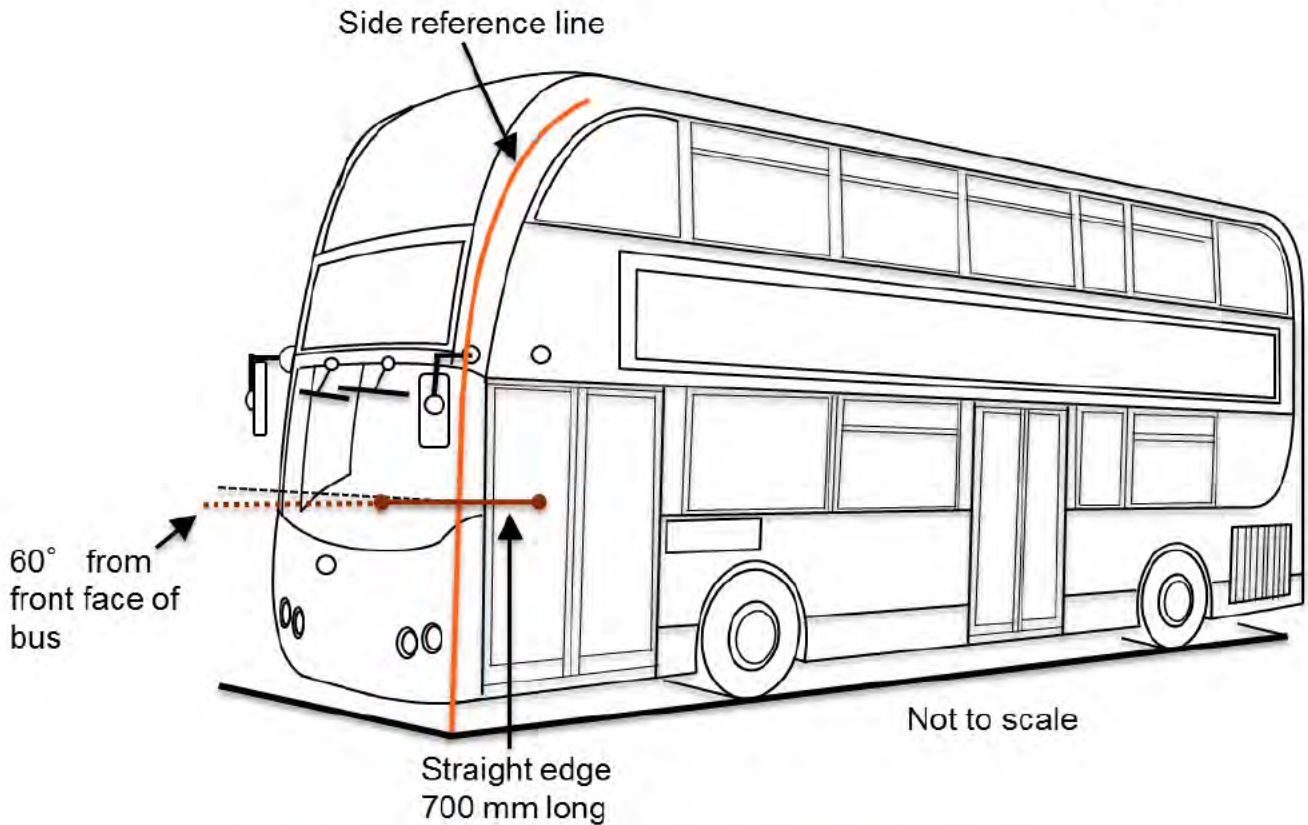

Figure 36_1b: Side reference line – front/side view

- Test Point** - means a point on the vehicle's outer surface selected for assessment with a head-form test. The contact/impact point is where the head-form's profile contacts the vehicle's outer surface cross section. This is coincident with the test point for a vertical windscreen, but it will not be coincident with the test point for tests with an inclined surface, e.g. a raked windscreen (See figure 36_2). However, in all cases, the result of the test shall be attributed to the test point, independent of where first contact occurs.

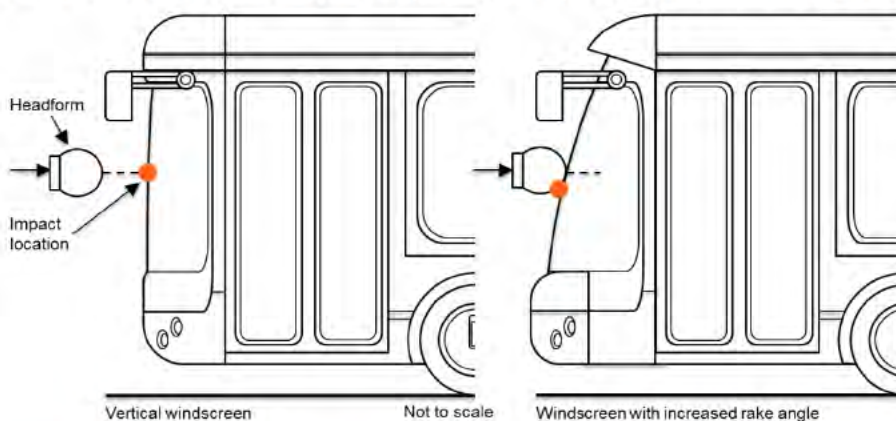

Figure 36_2 Contact/impact point coincident with test point for vertical windscreen but not coincident for raked windscreen

- Test Areas** - mean sub-divisions of the adult and child head-form test zones. Both the adult and child head-form test zones shall be divided into six test



areas labelled A1, A2, A3, A4, A5, A6 and C1, C2, C3, C4, C5, C6 See Figure 36_3.

To mark the position of the test areas the following procedure shall be used:

- Using taut flexible tape mark a vertical line which coincides with the vertical centreline of the bus through the adult and child head-form test zones along the outer surface of the bus.
- Using taut flexible tape measure distances from vertical centreline to left hand and right side reference lines of adult and child head-form test zones at the top and bottom of both test zones.

Divide these distances by three and using taut flexible tape mark points at tops and bottoms of boundaries of individual test areas and mark lines along the outer surface of the bus between these points to define the locations of test areas. Label test areas.

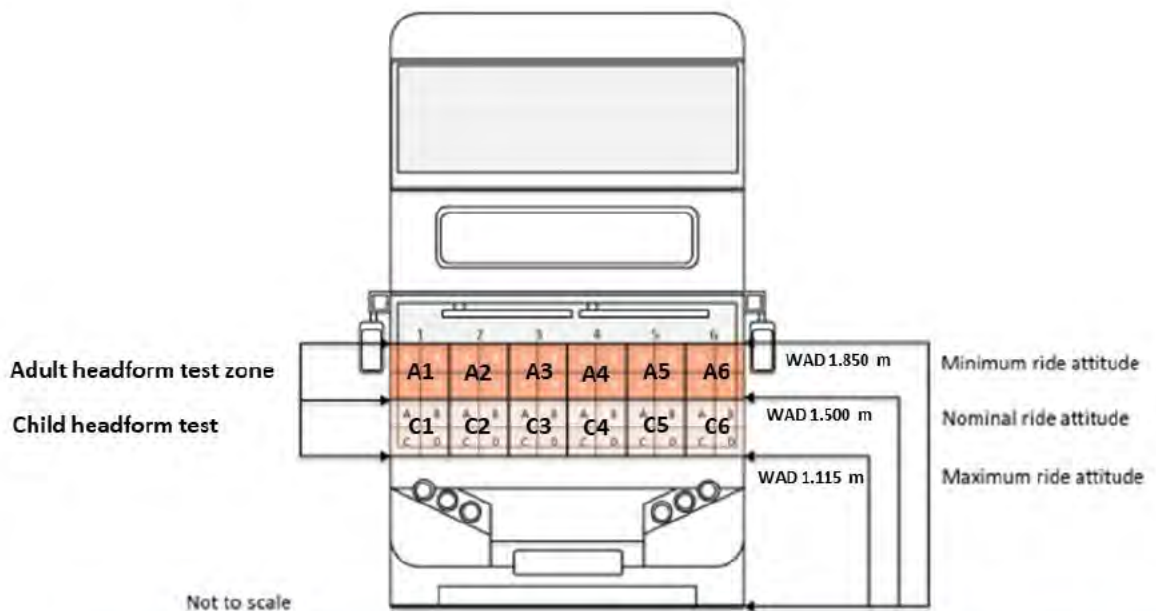

A	a	1	b	a	2	b	a	3	b	a	4	b	a	5	b	a	6	b
	c		d	c		d	c		d	c		d	c		d	c		d
C	a	1	b	a	2	b	a	3	b	a	4	b	a	5	b	a	6	b
	c		d	c		d	c		d	c		d	c		d	c		d

Figure 36_3: Labelling of test areas and sub-areas

- **Test sub-areas** – mean sub-divisions of the adult and child head-form test areas. Each test area consists of four equally sized sub-areas labelled a-d; see **Error! Reference source not found.6_3**.

To mark the position of the test sub-areas the following procedure shall be used:



- Using taut flexible tape mark midpoints of boundaries of individual test areas and mark straight lines between them along the outer surface of the bus to define the locations of test sub-sub areas. Label sub-areas
- **Unladen vehicle mass** - means the nominal mass of a complete vehicle as determined by the following criteria:

Mass of the vehicle with bodywork and all factory fitted equipment, electrical and auxiliary equipment for normal operation of the vehicle, including liquids, tools, fire extinguisher, standard spare parts, chocks and spare wheel, if fitted.

The fuel tank shall be filled to at least 90 per cent of rated capacity and the other liquid containing systems (except those used for water) to 100 per cent of the capacity specified by the OEM.

- **Vehicle type with regard to the pedestrian protection requirements** - means a category of vehicles with front end designs which, forward of the side reference lines, do not differ in such essential respects as:
 - a) The structure,
 - b) The main dimensions,
 - c) The materials of the outer surfaces of the vehicle,
 - d) The component arrangement (external or internal),

in so far as they may be considered to have a negative effect on the results of the impact tests prescribed in this Regulation.

- **Windscreen** - means the frontal glazing of the vehicle.
- **Wrap Around Distance (WAD)** - means the geometric trace described on the outer surface of the bus front end by one end of a flexible tape, when it is held in a vertical longitudinal plane of the vehicle and traversed across the bus front end. The tape is held taut throughout the operation with one end held at the same level as the ground reference plane, vertically below the front face of the bumper and the other end held in contact with the front structure (see Figure 36_4. The vehicle shall be either positioned in the maximum, minimum or nominal ride attitudes.

This procedure shall be followed, using alternative tapes of appropriate lengths, to describe wrap around distances of 1,115 mm (WAD1115), of 1,500 mm (WAD1500) and of 1,850 mm (WAD1850).

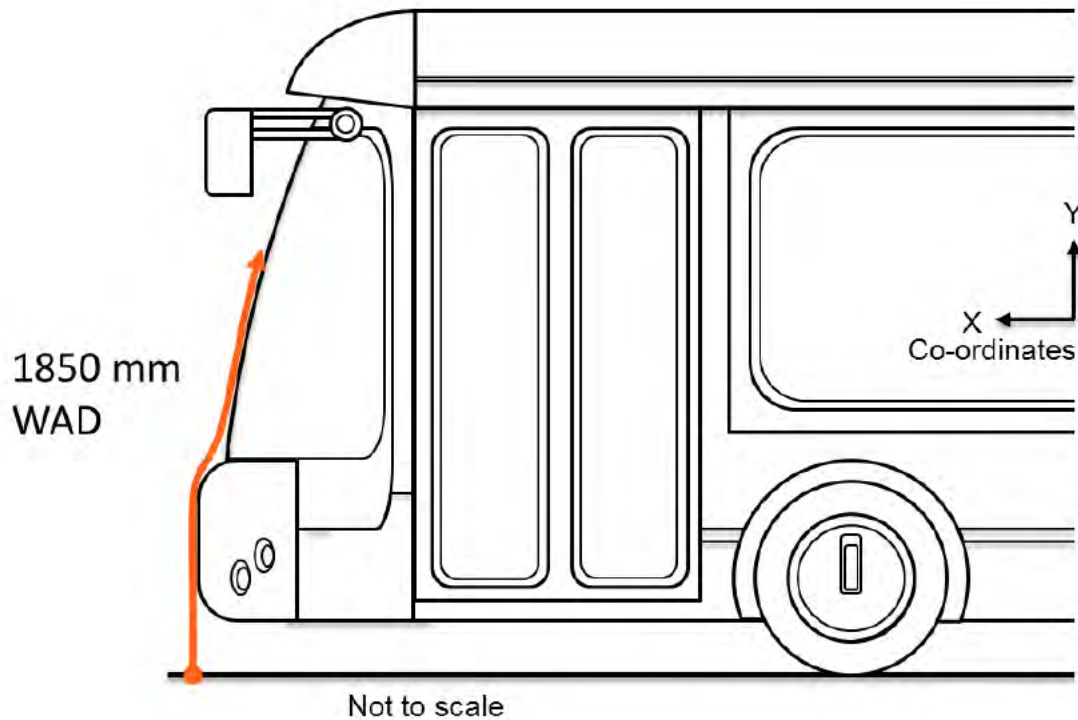

Figure 36_4: Wrap around distance measurement

6 Specifications

6.1 Minimum requirements

As specified in the London Bus Services limited New Bus Specification, Section 4.6.3:

- When tested in accordance with the test procedures in Section 8, all recorded HIC₁₅ values shall not exceed [1700]; and
- The Bus VRU Impact Test performance Score (BITS) must be, at least [70%].

6.1.1 Bus VRU Impact Test performance Score (BITS)

The Bus VRU Impact performance Score (BITS) shall be calculated for the bus front end using the following method:

1. Identify HIC₁₅ value recorded for each of the 6 adult and 6 child test areas
2. Convert HIC₁₅ values into points using the following scale and sum points for the 12 test areas:

HIC ₁₅ < 700	= 2 points	Green
700 ≤ HIC ₁₅ ≤ 1000	= 1.5 points	Yellow
1000 < HIC ₁₅ ≤ 1350	= 1.0 points	Orange
1350 < HIC ₁₅ ≤ 1700	= 0.5 points	Brown
1700 < HIC ₁₅	= 0 points	Red



3. The total points value shall be divided by 24 to give a value between 0 and 1 and results expressed as a percentage of the maximum possible value, i.e. multiply by 100.

7 Test procedure

Testing shall be performed with either a whole bus or a relevant part of the bus front-end structure which is representative of the bus being assessed.

For example, if the windscreen area covers at least the whole of the adult and child head-form test zones, it is permitted to perform tests on the windscreen and related structures alone mounted in a jig, provided that the windscreen and related structures (if any) are constrained in such a manner that their behaviour is representative as if they were part of a whole bus. An example of a related structure which may affect test results is a driver assault screen mounted 1 to 2 cm from the windscreen's inner surface.

In the case that a relevant part of the bus front-end structure is assessed, the bus manufacturer shall supply documentation which shows that it is representative of the bus being assessed and which includes drawings of the whole bus.

The testing organisation shall review this documentation to check representativeness of the front-end provided, in particular that:

- The windscreen is constrained in a representative manner.
- Any stiff structures, such as driver assault screens, that are located close to the windscreen, and which may influence test results by limiting windscreen deflection, are included in the representative front-end structure

7.1 Marking of assessment areas

1. Whole bus

The adult and child head-form test zones and associated test areas and test sub-areas shall be marked out following the procedures defined in Section 5 'Definitions' above.

2. Representative frontal structure

For a representative frontal structure measurement of WAD distance as defined in Section 5 'Definitions' above to mark the tops and bottoms of the adult and child head-form test zones may be a challenge. This is because the representative frontal structure may not include much bus structure below the test zones. In this case the manufacturer shall supply marked structures (with documentation to show correctly marked) or information to enable their marking. This information shall, as a minimum define, the locations for the corners of the test areas as shown in Figure 36_5.

The WAD boundaries of the adult and child head-form test zones shall be marked by interpolation between these points.

Boundaries of the test areas shall also be marked by interpolation between these points.

Boundaries of test sub-areas shall be marked following the procedures defined in Section 5 'Definitions' above.

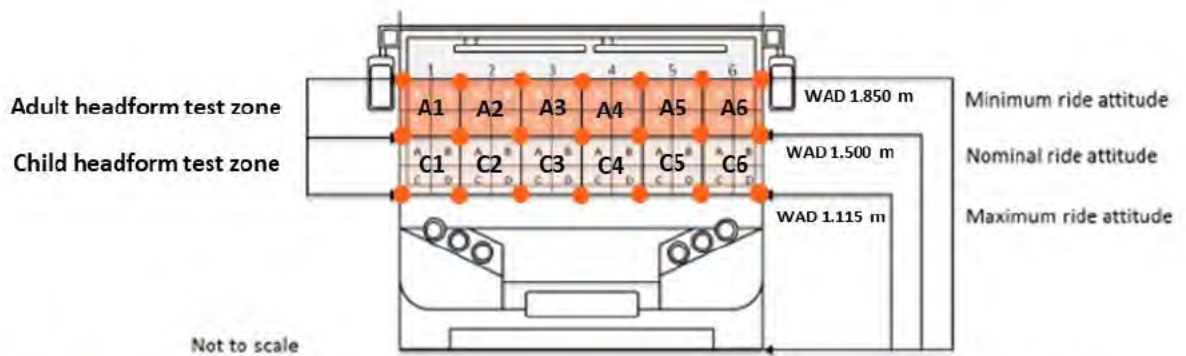

Figure 36_5: Minimum point data (indicated by orange points) required from manufacturers to define test zone WAD boundaries

7.2 Selection of test points and test speed

7.2.1 Test points

One test point shall be selected for each adult and child test area (A1, ...A6 & C1,C6; 12 test points in total) by the independent test service. The test points shall be selected to best meet the following criteria:

1. At least 165 mm distance from adjacent test point measured with a flexible tape held tautly along the outer surface of the vehicle.
2. Not likely to cause the impactor to impact the test sub-area with a glancing blow resulting in a more severe second impact outside the test area.
3. Expected to be most injurious test point within sub-area.
 - For guidance on the selection of most injurious test point, see Section 2.1.2 in:
 London Bus Service Limited New Bus Specification - Attachment 37: VRU Frontal Crashworthiness Energy Absorption Assessment Guidance Notes

The criteria are listed in priority order. If all criteria cannot be fulfilled the test point location shall be moved incrementally to best meet them in the order they are prioritised, e.g. location moved further away from point expected to be most injurious until 165 mm from adjacent test point.

The location of the test points selected and the reason for their selection shall be recorded in the test report.

7.2.2 Test speed

A test speed of either 11.1 m/s or 6.94 m/s shall be selected for each test point on a 'random' basis with the constraint that 11.1 m/s shall be selected for at least half of the test points, i.e. random selection until test speed of 6.94 m/s selected for 6 test points, after which 11.1 m/s selected for all remaining test points.



7.3 Impact test procedures

7.3.1 General test conditions

General test conditions shall be pursuant to Regulation 127.02, Annex 3 'general test conditions', sections 1 'Temperature and humidity' and 2 'impact test site'.

Any parts damaged by an impact must be replaced before carrying out the next test.

7.3.2 Test preparation

Either a complete vehicle or a representative frontal structure, adjusted to the following conditions, shall be used for the test:

- The vehicle shall be in its normal ride attitude, and shall be either securely mounted on raised supports or at rest on a flat horizontal surface with the parking brake applied.
- The representative frontal structure shall include, in the test, all parts of the vehicle front structure in the adult and child head-form test zones and all components behind the windscreen that may be involved in a frontal impact with the head of a vulnerable road user, to demonstrate the performance and interactions of all the contributory vehicle components. The representative frontal structure shall be securely mounted in the normal vehicle ride attitude.

All devices designed to protect vulnerable road users when impacted by the vehicle shall be correctly activated before and/or be active during the relevant test. It shall be the responsibility of the manufacturer to show that any devices will act as intended in a pedestrian impact.

If the vehicle is fitted with a badge, mascot or other structure, which would bend back or retract under an applied load of maximum 100N, then this load shall be applied before and/or while head-form impact tests are performed.

Any vehicle component which could change shape or position, other than suspension components or active devices to protect pedestrians, shall be set to their stowed position.

7.3.3 Specification and certification of head-form impactors

For all impact tests, the head-form impactors and the instrumentation fitted to them shall meet the specifications provided in Regulation 127.02, Annex 4 'Test impactor specifications', section 5 'Child and adult head-form impactors'.

Head-form impactors shall also be certified pursuant to Regulation 127.02, Annex 6 'Certification of the impactor', section 3 'Child and adult head-form'.

7.3.4 Which head-form impactor

Impact tests shall be performed for each selected test point at the selected test speed using the appropriate head-form impactors. These are child head-form impactor for test points within the child test zone and adult head-form impactor for test points within the adult test zone.

7.3.5 Alignment and speed of head-form impactors

The head-form impactor shall be propelled at the selected test point in the x-direction parallel to the longitudinal axis of the vehicle (for a bus with a vertical front-end this is normal to the front surface).

The centre of gravity of the head-form shall be aligned with the test point (Figure 36_6).

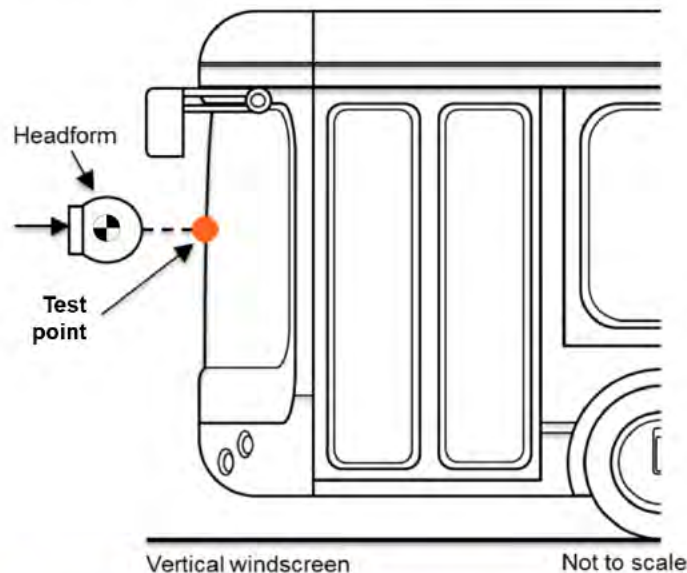

Figure 36_6: Alignment of head-form impactor with test point

The impact speed shall be that selected for the individual test point with a tolerance of ± 0.2 m/s.

7.3.6 Propulsion of head-form impactors

The head-form impactors shall be in “free flight” at the moment of impact, at the selected impact velocity and the required direction of impact. The impactors shall be released to “free flight” at such a distance from the vehicle that the test results are not influenced by contact of the impactor with the propulsion system during rebound of the impactor.

7.3.7 Measurement of impact velocity

The velocity of the head-form impactor shall be measured at some point during the free flight before impact, in accordance with the method specified in ISO 3784:1976. The measured velocity shall be adjusted considering all factors which may affect the impactor between the point of measurement and the point of impact, in order to determine the velocity of the impactor at the time of impact. The angle of the velocity vector at the time of impact shall be calculated or measured.

7.3.8 Accuracy of impact

A nominal vertical and lateral impact location tolerance of ± 10 mm shall apply. This tolerance shall be measured along the surface of the vehicle front and does not include differences caused by the test point and contact point not being coincident for impacts against surfaces which are not normal to the head-form propulsion direction (Figure). In these cases, the distance between the test point and the contact point calculated theoretically can be added to the tolerance specified above (± 10 mm) in the direction affected, e.g. vertical direction for case shown in Figure .

The test laboratory may verify, at a sufficient number of test points, that this condition can be met and the tests are thus being conducted with the necessary accuracy.

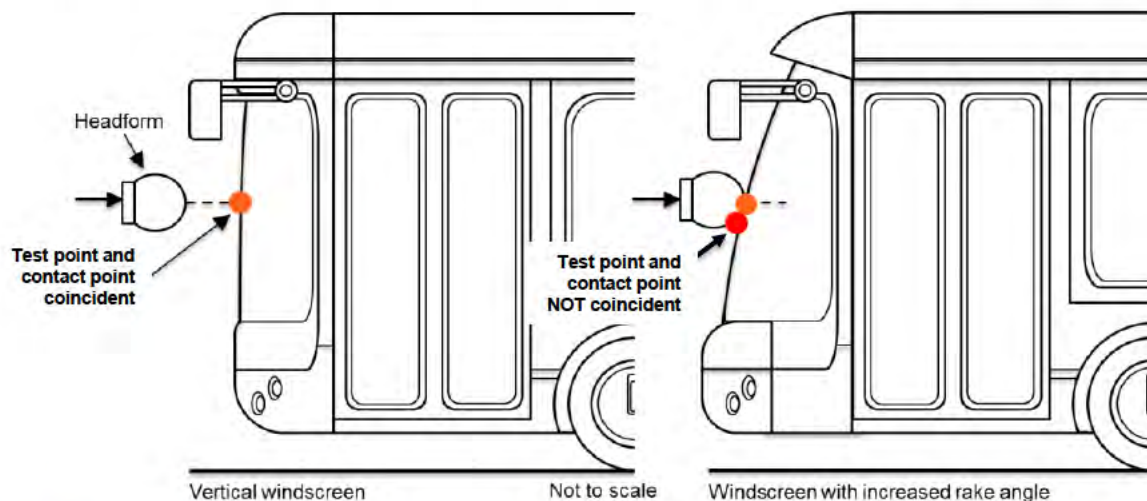

Figure 36_7: Test point and head-form contact point not coincident for impacts against surface not normal to direction of propulsion

7.3.9 Recording of test results

The acceleration time histories shall be recorded, and HIC shall be calculated. The measuring point on the bus front end shall be recorded. Recording of test results shall be in accordance with ISO 6487:2002 shall be perpendicular to the lateral vertical plane of the vehicle to be tested.

7.4 Atypical windscreen fracture

Tests may be repeated in case of atypical windscreen fracture. The repetition of the test is at manufacturer's request where the HIC_{15} value exceeds 1000. In this case, the maximum number of repetitions on a test point is 3 (i.e. 4 tests total). The value of HIC_{15} for the repeat test with a non-atypical windscreen fracture shall be the one used to ascertain whether minimum requirements met (i.e. $HIC_{15} \leq 1700$), to calculate the BITS and for verification of simulation results.



8 Test Report

The independent Test Service shall provide a comprehensive Test Report that will be made available to TfL. The test report shall consist of three distinct sections:

- a) Reference information
- b) Confirmation of protocol compliance
- c) Performance data

8.1 Reference information

- a) As a minimum, the Test Service shall provide reference information including:
 - b) Make (trade name of OEM);
 - c) Model/Type;
 - d) Commercial name(s) (if available);
 - e) Means of identification of type, if marked on the vehicle;
 - f) Location of that marking;
 - g) Variant (if applicable);
 - h) Category of vehicle;
 - i) Name and address of OEM;
 - j) Name(s) and address(es) of assembly plant(s);
 - k) Name and address of the OEM's representative (if any);
 - l) General construction characteristics of the vehicle;
 - m) Photographs and/or drawings of a representative vehicle;
 - n) Bodywork;
 - o) Type of bodywork;
 - p) Materials used and methods of construction;
 - q) Running order information;
 - r) Pedestrian protection;
 - s) A detailed description, including photographs and/or drawings, of the vehicle with respect to the structure, the dimensions, the relevant reference lines and the constituent materials of the frontal part of the vehicle (interior and exterior) shall be provided.

8.2 Confirmation of protocol compliance

Predominantly this item will relate to providing a description of testing completed.

The test points selected and a brief description of the reasons for their selection (e.g. reason why test point location judged to be most injurious in sub-area) shall be indicated in the test report. The sub-area of each zone shall be noted as well as specific descriptions of the structures contacted during the test.



Photographs shall be taken of each test position before and after each test.

Records should be kept of the components changed between tests due to damage.

8.3 Performance data

Every test shall be reported along with the corresponding HIC₁₅ value.

Furthermore, the BITS points value associated with each result shall be recorded as well as the overall BITS value for the bus (Table 36_1 provides a blank example of a results table).

The BITS scores should also be presented visually. Such images shall be colour coded to distinguish between the tests receiving 0, 1 or 2 points. A legend to the colour coding shall be provided within the Test Report. A hypothetical example is shown in Figure 36_8.

Test site	Quadrant tested	Brief description of reason for selection of (most injurious) test point position	HIC ₁₅	BITS points value
A1	A, B, C or D	e.g. No structure present likely to interfere with windscreen deformation, so closest point to edge of windscreen chosen.	XXX	YY
A2				
A3				0
A3*				
A4				
A5				
A6				
C1				
C2				
C3				
C4				
C5				
C6				
Total				
			BITS (%) =	(Total points)*100/24

Table 36_1: Example table for reporting of results

* Repeat test because first test resulted in atypical windscreen fracture. Atypical test results noted for record but struck through.

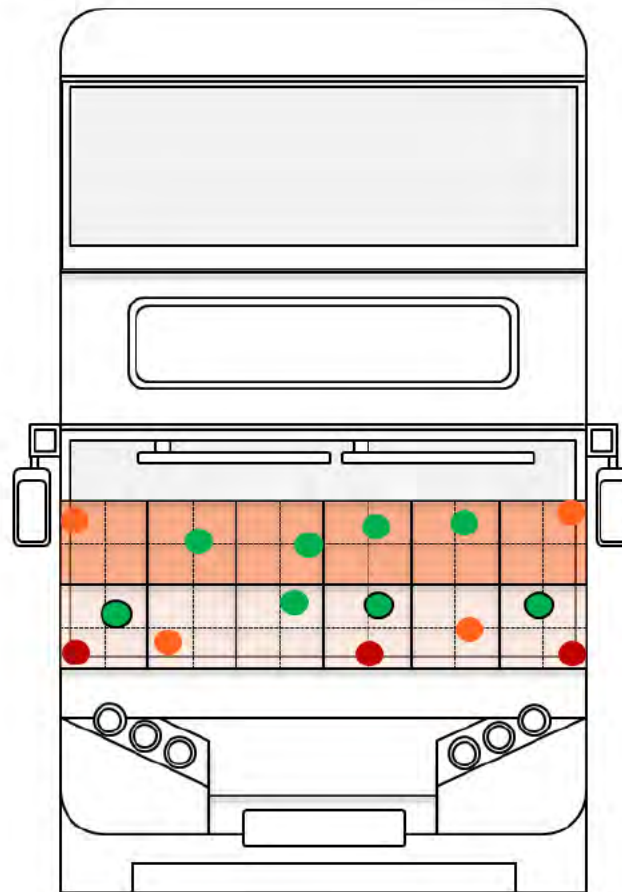

Not to scale

Figure 36_8: Example image showing test results from Bus VRU frontal crashworthiness energy absorption assessment protocol

9 Simulation procedure

The procedure to assess the bus on the basis of simulation is as follows:

9.1 Manufacturer: Identify test points and perform simulated impacts

- Manufacturer selects a test point (and test speed) for all test sub-areas in adult and child head-form test zones following similar procedure as in Section 7.2 for test areas, i.e. select test point (and test speed) in assessment sub-area on the basis of the criteria listed. Note that all tests within a sub-area shall be performed at the same test speed.
- Manufacturer performs head impact simulation for each selected test point at appropriate test speed and supplies the HIC₁₅ values predicted to independent test service.



9.2 Independent test service: Perform verification tests and assess simulated results

- Independent test service performs verification tests and assesses results provided as follows:

1. Minimum requirement – $HIC_{15} \leq [1700]$

- i. Shall be achieved for all test sub-areas, i.e. for all predicted results supplied.

For example (see **Error! Reference source not found.36_9**), minimum requirement met for all test points.

2. Bus VRU Impact Test Score (BITS) – calculate as follows:

- i. Calculate predicted BITS value:

- Identify largest HIC_{15} value (and associated test points) for each of the 6 adult and 6 child test areas.

For example (see **Error! Reference source not found.**), largest HIC value for each sub-area identified with black squares.

- Convert HIC_{15} values into points using the following scale and sum points for the 12 sub-areas:

$HIC_{15} < 700$	= 2 points	Green
$700 \leq HIC_{15} \leq 1000$	= 1.5 points	Yellow
$1000 < HIC_{15} \leq 1350$	= 1.0 points	Orange
$1350 < HIC_{15} \leq 1700$	= 0.5 points	Brown
$HIC_{15} > 1700$	= 0 points	Red

For example (see **Error! Reference source not found.**), points value by sub-area:

Sub-area	Points value:
A1	yellow 1.5
A2	green 2
A3	green 2
A4	green 2
A5	orange 1
A6	yellow 1.5
C1	orange 1
C2	orange 1
C3	yellow 1.5
C4	yellow 1.5
C5	orange 1
C6	yellow 1.5

Totals points = 17.5, (4 orange, 5 yellow, 3 green)

- The total points value shall be divided by 24 to give a value between 0 and 1 and results expressed as a percentage of the maximum value possible, i.e. multiply by 100.

For example (see **Error! Reference source not found.**), BITS value

$$BITS = 17.5/24 * 100 = 73\%$$

- ii. Perform verification tests and calculate correction factor.



- From the 12 test points identified for each of 6 adult and 6 child test areas above, i.e. those associated with largest HIC₁₅ values, identify 5 verification test points by random selection and distributed in line with predicted test area colour distribution.

For example (see **Error! Reference source not found.**), the colour distribution for all 12 test points is 4 orange, 5 yellow and 3 green. So the 5 verification test points selected will be 2 orange, 2 yellow and 1 green test points selected randomly (see the boxes marked with crosses in **Error! Reference source not found.**).

- Perform verification tests for 5 selected points.
- Calculate test point colour value for verification test points
Because HIC₁₅ values from tests can vary, a 10% tolerance shall be applied to the measured HIC₁₅ test value to calculate the verification test points (colour) value. This is done by using the 'Accepted HIC₁₅ range' right hand column in **Error! Reference source not found.**. The tolerance is applied in both directions, meaning that even when a tested point scores better than that predicted by simulation, but is still within tolerance range, the predicted colour value is applied. For example, if test point predicted HIC₁₅ colour value was yellow and verification test HIC₁₅ measured value was 650, the verification test point value is still yellow, i.e. 1.5 points.

However, this tolerance only applies to verify that the test point simulated and measured points values are the same. When, once the tolerance is applied and the test colour value is not the same as the predicted colour value, then the colour of the test verification point will be determined by using the 'Predicted HIC₁₅ range' scale (see **Error! Reference source not found.**, middle column) which does not apply a tolerance to the HIC₁₅ value as in the 'Accepted HIC₁₅ range' column. For example, if the predicted test point colour value was yellow and the measured test point HIC₁₅ was 1400, the test colour value would be brown.

Points (colour) value	Predicted (simulated) HIC ₁₅ range	Accepted HIC ₁₅ range for test results
Green (2 points)	HIC ₁₅ < 700	HIC ₁₅ < 777
Yellow (1.5 points)	700 ≤ HIC ₁₅ ≤ 1000	636 ≤ HIC ₁₅ ≤ 1111
Orange (1.0 points)	1000 < HIC ₁₅ ≤ 1350	909 < HIC ₁₅ ≤ 1500
Brown (0.5 points)	1350 < HIC ₁₅ ≤ 1700	1227 < HIC ₁₅ ≤ 1889
Red (0 points)	1700 < HIC ₁₅	1545 < HIC ₁₅

Table 36_2: Chart to calculate points (colour) value from HIC₁₅ value for simulated and test results

- Calculate correction factor
The actual tested total value of the verification test points shall be divided by the predicted total value of these verification test points to calculate the correction factor, which can be lower or higher than 1.

$$\text{Correction factor} = \frac{\text{Actual total verification test point score}}{\text{Predicted total verification test point score}}$$

For example, total points value for verification tests = 6.50

Verification			
Test point	Prediction	Value	Points
A3A	2	700	2
A5C	1	1200	1
A6A	1.5	800	1.5
C1C	1	1150	1
C4D	1.5	1150	1
Total	7.00		6.50
Correction factor			0.928571

$$\text{Correction factor} = 6.5 / 7.00 = 0.929$$

- iii. Apply correction factor to calculate verified BITS value

$$\text{Verified BITS} = \text{Predicted BITS} * \text{CF}$$

For example:

$$\text{Verified BITS} = 73\% * 0.929 = 68\%$$



Figure 36_9: Example to illustrate simulation procedure; colour coded data supplied by manufacturer, selection of verification test points, and calculation of BITS value. Simulated test results shown by colour code, boxes identify the sub-areas with highest HIC15 within the twelve test areas and crosses identify test points for chosen verification tests





Attachment 37: Bus VRU Frontal Crashworthiness Energy Absorption Assessment Protocol Guidance Notes

1 Introduction

Bus fronts have been identified as one of the key contact causing parts of the vehicle in collisions with Vulnerable Road Users (VRU). Therefore, all bus front ends, in the region of potential head contacts, are required to have a construction that absorbs energy and protects VRUs in the event of a contact at that location on the vehicle.

As such, all buses shall have their VRU impact testing performance assessed against the associated VRU impact testing protocol. All buses shall have front ends which are energy absorbing or sufficiently compliant or frangible to meet the performance requirements.

This document sets out the guidance notes related to the assessment of VRU impact performance. These guidance notes are aimed at bus operators and OEMs as a practical guide for implementation of the Bus VRU Frontal Crashworthiness Energy Absorption Assessment Protocol.

These notes are for guidance only and are not legally binding. In all circumstances, the guidance provided by an OEM or system supplier shall take precedence, and these guidance notes are only for use in the absence of other information. These are not intended to be exhaustive, but to point the operators toward practical advice and questions to raise with OEMs/suppliers.

2 Procedure background

Test procedures for the assessment of the structural interaction between passenger cars and pedestrians exist, both for type approval purposes (UN Regulation No. 127 and UN GTR No. 9) and for use in consumer assessment ratings of vehicles (e.g. Euro NCAP). These existing protocols have been used as a basis for the development of a test procedure for the assessment of the protection for Vulnerable Road Users (VRU) in impacts with buses. This procedure extends and modifies that already developed within the Aprosys Project for Heavy Goods Vehicles.

2.1 Vehicle preparation and marking

The protocol specifies the marking out of the front of the vehicle into two test zones, one an adult test zone, and the other a child test zone. The adult test zone is the area where the head of an adult pedestrian is likely to hit and the child test zone is the equivalent area for a child pedestrian. The marking procedure includes allowances for changes in ride height of the vehicle and defines the “corners” of the vehicle at either side. The lower boundary of the test zone is defined with the vehicle at its normal ride height, and the upper boundary with the vehicle at its minimum ride



height. The heights of the boundaries were defined based on anthropometric data as part of the Aprosys project¹, with, for example, the maximum boundary height of 1850 mm relating to the height of a 95th percentile adult male.

2.1.1 Marking out the test areas

The protocol requires that the vertical boundaries of the test areas are marked out at defined Wrap Around Distances (WADs) by traversing flexible tapes of appropriate lengths across the front of the bus as shown in the protocol **Error! Reference source not found.**

In the case that a representative frontal structure is being assessed it may not be possible to do this at the test house because the lower part of the bus structure below the test areas may not be included in the representative structure. In this case the protocol requires that the manufacturer supplies the locations for the corners of the test areas as shown in the protocol Figure .

For the bus windscreens assessed in the test TfL test programme, it was found that the height above ground reference for vertical boundaries of the test areas varied little across the bus front-end, less than +/- 5 mm. Practically, it is much simpler and quicker to mark out a horizontal line at a constant height above the ground across the bus front-end compared to marking at least 7 points accurately using manufacturer supplied data and forming a horizontal line by joining them.

Given that the tolerance of mark out can be up to circa +/- 5 mm, provided the variation in the height above ground reference of the vertical boundaries of the assessment areas across the front of the bus calculated using WAD is less than +/- 5 mm, it is permitted to mark these boundaries using a constant height above the ground.

2.1.2 Selection of test points

To select the test point expected to be the most injurious within a test area, the independent test service should at least take into account stiff structures and the proximity of the test point to them. Examples of stiff structures include:

- Where the windscreen is bonded to the underlying bus structure
- Structures, such as assault screens, parts of which may be located close to the windscreen and could interfere with the windscreen's deformation when it is impacted by a head.
- Locations where hinges attach for openings such as inspection covers

In cases where these types of stiff structures are within a test area a test point location should be selected in alignment with them. In cases where they are located close to a test area a test point location within the test area as close as possible to them should be selected.

¹ Feist F, Jurgen G, Robinson T, Fabbender S, Niewohner W, Barrios J, Aparicio A. (2009) The Heavy Goods Vehicle aggressivity index. 21st ESV conference, June 2009. <https://www-esv.nhtsa.dot.gov/Proceedings/21/09-0323.pdf>



2.1.3 Testing

The testing is carried out with air, spring or hydraulically propelled head-forms. The protocol provides details of how to position the head-form. The head-form is propelled at the vehicle in the x-direction parallel to the longitudinal axis of the vehicle (nominally this is normal to the surface).

The testing is carried out using an adult head-form and a child head-form for the respective test zones. The prime test speed used is $11.1 \pm 0.2\text{m/s}$. A second speed of $6.94 \pm 0.2\text{m/s}$ will be used in addition for at least one of the test points in each zone. These lower speed tests will be selected at random from the proposed matrix of tests.

To avoid repeated testing of the same parts, no two tests are allowed within 165 mm (an adult head/head-form diameter).

2.1.4 Atypical windscreen fracture

Currently, when subjected to a head impact test, a windscreen may break in an atypical manner with late fracturing resulting in high deceleration values and high HIC values. In the protocol this issue has been addressed by a temporary provision allowing retesting and providing the respective industries sufficient lead time to finalise the properties of windscreen glazing so that they do not break in an atypical manner.

How to define an atypical test result is written in the protocol and is similar to the definition in UN Regulation 127.03².

- **Atypical windscreen fracture behaviour** is where the head-form to windscreen impact results in at least one of the following cases:
 - (a) The minimum value of the derivation of the head-form acceleration versus time is greater than -180 g/ms for 4 ms after the initial contact of the head-form to the windscreen; or
 - (b) The minimum value of the acceleration below 300 m/s^2 between the initial peak and 10 milliseconds is reached later than 4 ms in the time/acceleration plot, or glass breaking which expands to a large part of the windshield is not visibly observed.

To help interpret this definition correctly, information, which includes examples of typical and atypical test results, is given below.

The definition is based on the two methods that research found to identify atypical test results from the head-form acceleration traces, namely:

- Case (a) – method based on the rate of change (derivation) of the acceleration referred to as the ‘jerk criteria’
- Case (b) – method based on the shape of the acceleration curve referred to as the ‘pattern criteria’.

Because neither method correctly differentiated between all typical and atypical acceleration traces, it was decided to define an acceleration trace as atypical when

² Proposal for the 03 series of amendment to UN Regulation 127:
https://unece.org/sites/default/files/2022-05/ECE_TRANS_WP.29_2022_70E.pdf



at least one of the methods identified it as such on the basis that the primary objective was to identify atypical test results.

Case (a) 'jerk criteria' method

Examples of acceleration traces identified as atypical and typical by the case (a) 'jerk' criteria are shown in Figure . The head acceleration (blue) curves are differentiated to give the jerk (red) curves. The minimum value of these curves before 4 ms is examined (see orange boxes) and if this is greater than -180g/ms (e.g. -35g/ms), the windscreen fracture for the test is identified as atypical and if less than -180g/ms (e.g. -500g/ms) identified as typical.

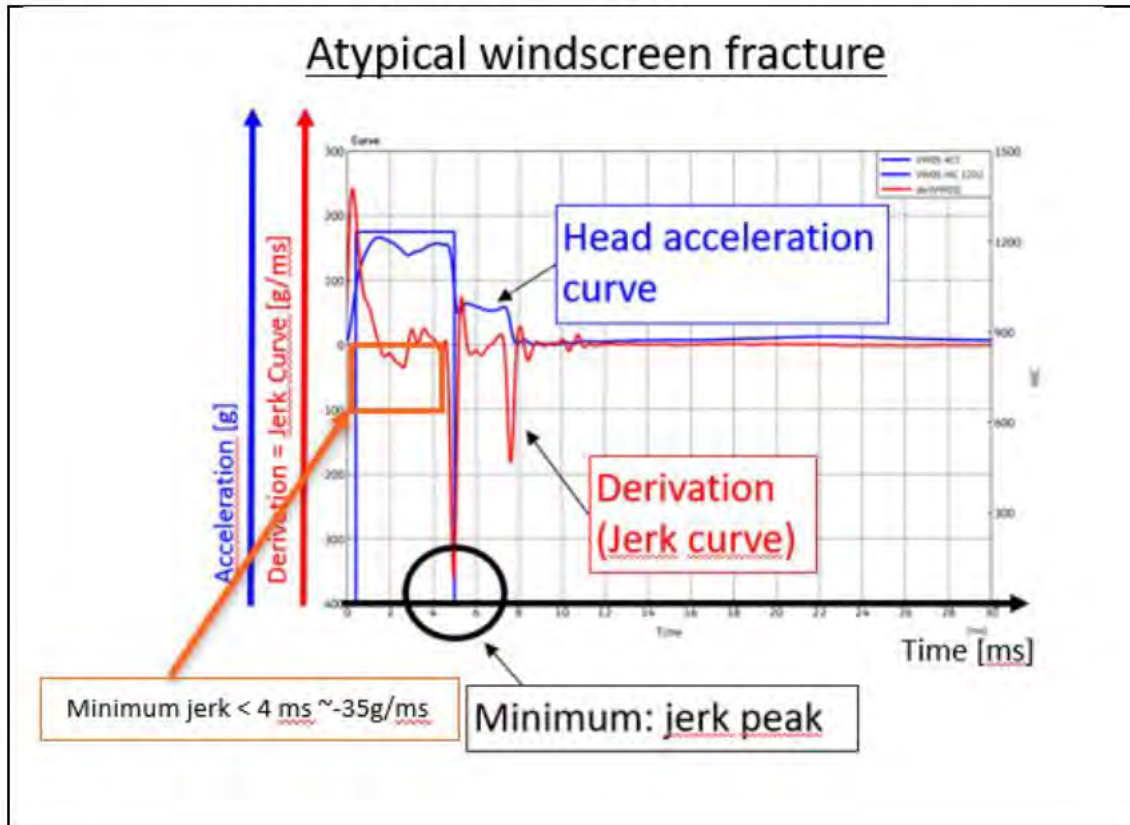

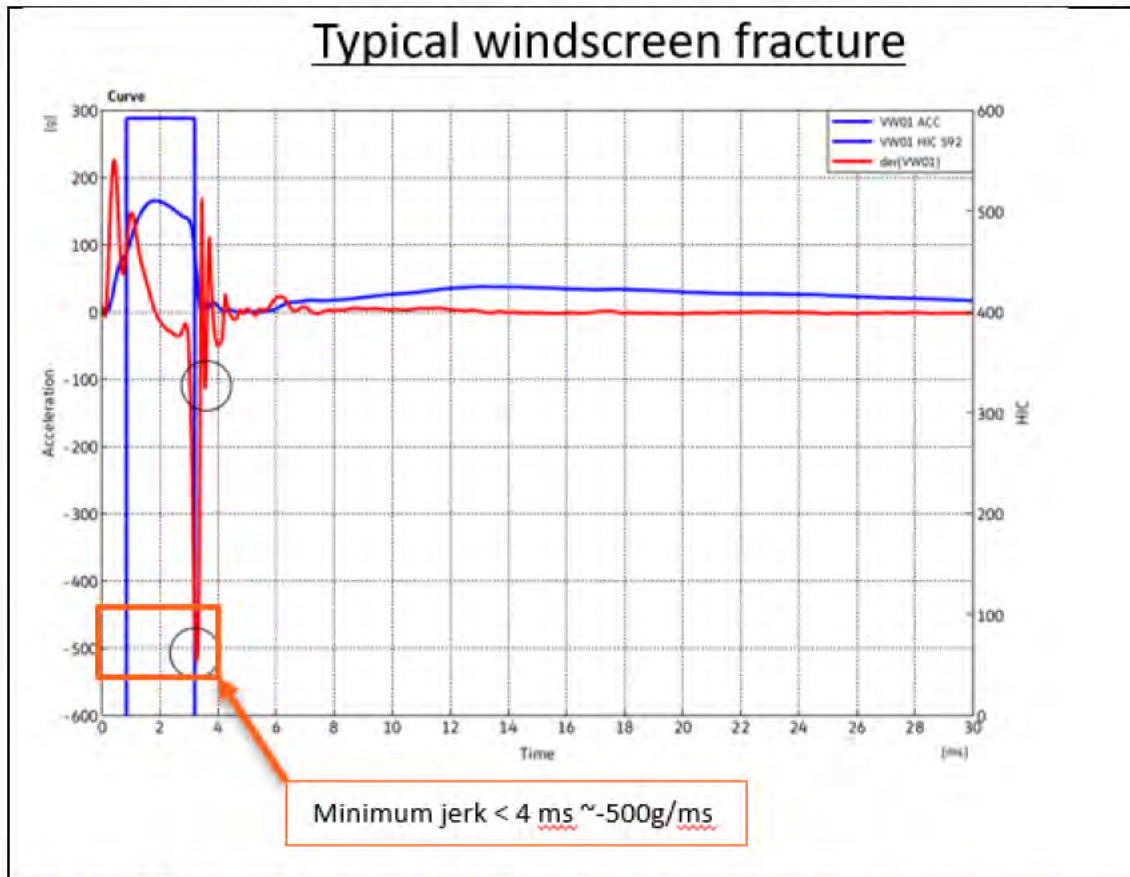

Figure 37_1: Examples of identification of atypical and typical windscreen fractures using 'jerk criteria' method case (a). Note that time duration HIC calculated over and value shown with blue rectangular shapes

Case (b) 'pattern criteria' method

Examples of deceleration traces identified as atypical (Pattern C and D) and typical (Pattern A and B) using the 'pattern criteria' method are shown in **Error! Reference source not found.** below.



Acceleration Time History Patterns

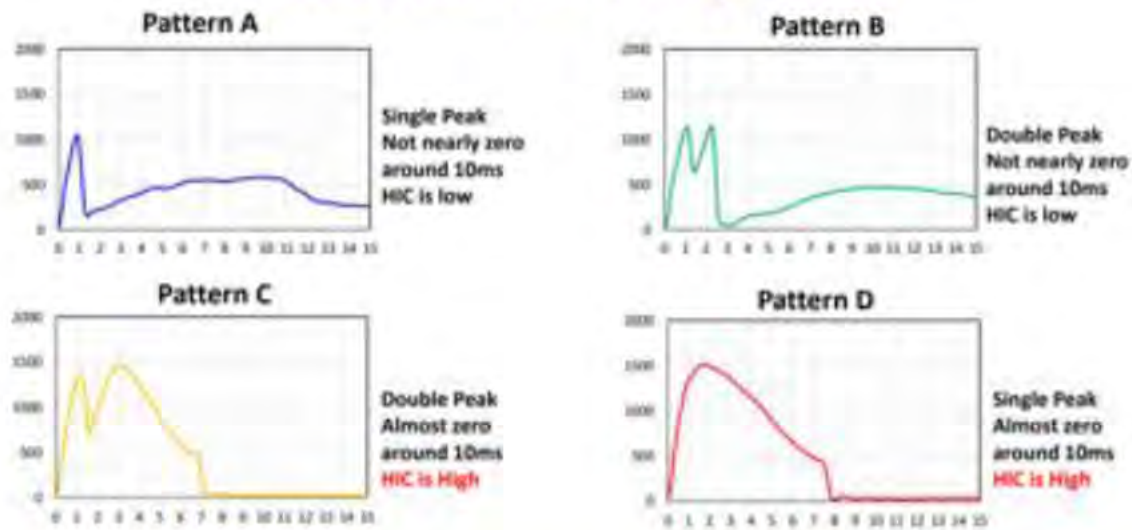

Figure 37_2 Examples of identification of atypical (Pattern C and D) and typical (Pattern A and B) windscreen fractures using 'pattern criteria' method case (b)

3 Selection of buses/systems

Any bus that meets the TfL Bus Vehicle Specification.

The VRU Impact Protection requirements may be assessed against a new build bus.

3.1 Compliance and warranty

A bus operator should ask to see a VRU Impact Performance test report from the OEM including the performance rating (a value between 0 and 1).

3.2 Interpreting the requirements and selecting the most effective way to fulfil them

The requirements relate to the energy-absorbing compliance or frangibility of the bus front end. In order to minimise the acceleration transmitted to the head of a vulnerable road user in the event of a collision, then the following elements should be avoided or minimised:

- **Stiff:** Wherever possible yielding structures should be provided to avoid high head decelerations.
- **Heavily featured:** As mentioned under sharpness, transitions of features on a bus front end that involve changes in angle are likely to provide natural stiffness to the structure. Therefore, ideally any changes in profile throughout the head impact areas should be progressive, offering a relatively flat compliant surface.
- **Robust:** One of the most important features for components such as windscreens is their ability to fracture during an impact. The onset of fracturing should be as early as possible in the impact event to gain full advantage of that energy-absorbing failure. For glazing this could be tuned through careful selection of thickness, composition of layers and potentially



the manufacturing process, etc. Advice from windscreen manufacturers may need to be sought on compliance with regulated behaviour of screens and tuning impact performance.

- **Sharp:** In accordance with the requirements of exterior projections, then sharp edges and features must be avoided on the outer surface of a vehicle (in locations where they may contact a vulnerable road user). Furthermore, tight radii tend to concentrate stiffness and hence should be avoided from the point of minimising the acceleration of a contacting head or head-form.

In the first instance, the Bus Vehicle Specification (BVS) and associated impact test and assessment procedure recognises that current buses already have large flat glazed areas on the front of the vehicle which have useful frangible properties for head protection. It is expected that the minimum standard can be met with conventional design techniques. However, through the performance rating, it will recognise improvements over and above this minimum standard if further improvements and tuning of the front end structures can be provided.

3.3 Susceptibility to damage

Increasing the tendency for glazing to fracture will have an adverse consequence on the ability of a windscreen to be durable and resistant to damage. For this reason, the current levels of performance required to achieve a high Bus Impact Test performance Score (BITS) are conservative. The precise definitions have been set around evidence of existing performance for bus fronts. However, if a technical solution can be provided that allows lower HIC test values without deteriorating maintenance costs and concerns and screen strength, then more stringent levels of performance could be encouraged.

3.4 Features sharing other functional requirements

To ensure that the front end of a bus performs well in other crash and failure modes, then certain requirements are placed for there to be strong structural members within the broad VRU contact area. To demonstrate crash protection for bus drivers, UN Regulation 29 (with regard to the protection of the occupants of the cab of a commercial vehicle) has been used by some OEMs. The need to meet these structural requirements must coexist with new requirements for VRU impact protection. Experience within the passenger car industry says that the two design goals are not mutually exclusive. Effective VRU protection is at such a different level of stiffness to other crashworthiness protection that both sets of parts must be designed to act in series (with the VRU protection being placed in front of stiffer components). The consequence of this is that sufficient clearance must be designed between the exterior surface and underlying stiff parts to allow deformation and cushioning during a VRU collision. The conflicts over packaging are recognised in this regard, but based on the experience with existing design of bus front ends are not considered to be prohibitive. Careful tuning of stiffnesses within deformable elements (as with car bumpers and bonnets) will minimise the clearance necessary to meet the VRU impact performance requirements.



4 Training

4.1 For independent test services

To be considered suitable as an independent test service, test houses shall be able to demonstrate a capability to undertake approval tests to UN Regulation No. 127 or UN Regulation GTR No. 9. To be used as a test service, they will be considered suitable to undertake performance tests. Test houses without such accreditation will also be required to demonstrate to TfL at their expense that they have the necessary expertise, equipment and quality control systems to be able to perform the head-form tests and produce the associated test report as required in the protocol described by Attachment 36.